

BWS BEST WAY
STONE®



CREATE.
PLAN.
BUILD.

2026 PRODUCT GUIDE



OVER 60 YEARS OF THE
BEST PRODUCTS BUILT
USING THE BEST PRACTICES.
THAT'S THE BEST WAY.

TO OUR VALUED CUSTOMERS

Since 1965, Best Way Stone has proudly stood as an independently owned and operated business built on a foundation of craftsmanship, quality and trust. For more than six decades, we have dedicated ourselves to delivering products that stand the test of time through style, durability, and the relationships we've formed along the way. At Best Way Stone, we believe that every product we produce is a commitment to you.

Being one of the few independently owned precast concrete manufacturers in the industry is more than just a distinction - it's what empowers us to deliver unparalleled service. Our independence ensures we remain flexible and responsive to the evolving needs of our customers by offering innovative solutions without ever compromising on quality.

Whether you're a homeowner transforming your outdoor space or a contractor seeking reliable, high-performance products to exceed client expectations, we're here to help bring your vision to life. Our pavers are backed by our lifetime guarantee, a testament to our unquavering commitment to you.

As we've grown, so too has our dedication to continuous improvement and exceptional service. Each member of our team is united by a shared mission: to provide you with an outstanding experience that is built on trust, innovation and craftsmanship.

Thank you for choosing Best Way Stone. We're here to support you - today, tomorrow, and for many years to come.

Warm regards,
The Best Way Stone Team

OUR TRUSTED DEALER NETWORK

BWS ProElite

Join the Best Way Stone family by connecting with one of our trusted dealers, conveniently located across Ontario, Quebec, the Maritimes, Michigan and Ohio. Our dealers don't just offer products, they bring your vision to life by recommending the perfect solutions, tailored to your unique design and style preferences. Whether you're planning a backyard oasis or a commercial project, our expert dealer network is here to guide you every step of the way.

Partnering with the Right Skilled Contractor

A well-crafted outdoor space begins with a skilled professional. Hiring a qualified hardscaper ensures that your project is executed smoothly and meets the highest standards. When selecting a contractor, consider these important tips:

Ask for references and past work: Review their portfolio to see if their style aligns with your vision.

Verify insurance, licensing, and warranty: Ensure they offer solid protection and guarantees for peace of mind.

Insist on industry-standard installation: Professional contractors should aim to adhere to best practices and guidelines recognized by the industry.

Consider choosing a ProElite Contractor, recognized by Best Way Stone for their commitment to quality craftsmanship. These select professionals work with Best Way Stone products and have a proven track record of delivering exceptional results. You can find our ProElite contractors at bestwaystone.com/find-a-hardscaper.

Professional hardscape contractors will understand the industry standards for installing hardscape products. You can download a copy of these guidelines by visiting masonryandhardscapes.org.



Visit our website to find a dealer near you:
bestwaystone.com/dealers

WE HAVE A GOOD FOUNDATION



Best Way Stone's products are designed to be resistant to the elements, meeting or exceeding CSA and ASTM industry standards.



We select the best performing ingredients for our products. Partnering with suppliers who value quality and service first like us.



Our production team carefully inspects each unit of product before it leaves our factory. The commitment to quality is backed by our transferable lifetime guarantee on the structural integrity of our pavers.

Visit our website to learn more about our transferable lifetime guarantee:

bestwaystone.com/warranty

Manufacturing Leads Design

Hardscaping solutions should be designed to last. Our philosophy is that manufacturing processes should always influence product design.

Thoughtful Innovation

Our production facilities are equipped with technology for our own proprietary processes that are specifically engineered to ensure our products are well-planned, well-designed and well-man.

With two state-of-the-art facilities, as well as dealers across Ontario, Quebec, the Maritimes, Michigan and Ohio, Best Way Stone is completely independent and able to both hear and respond to your needs.

THE PURSUIT OF BETTER

OUR TECHNOLOGIES



DesignLoc® technology is a two-stage manufacturing process that creates a refined surface while reinforcing a stronger, coarser base. This process enhances durability and reduces the potential for colour fading, ensuring a long-lasting, high-quality finish.



ChromaTec™ is a factory-applied protective surface enhancer that creates a barrier against stains from external elements. This coating not only helps to resist staining but also enhances the vibrancy and colour longevity of the product.



NanoBlast™ is a fine shot-blasting process that exposes specially selected aggregates on the product's surface. Combined with a brushed surface treatment, NanoBlast™ creates a striking textural contrast while delivering a more slip-resistant and comfortable finish.

EXPLORE BEST WAY STONE'S SERIES OF PRODUCTS THAT PROVIDE THEIR OWN UNIQUE ADVANTAGES TO YOUR SPACE

CLASSIC SERIES

The Classic Series represents the foundation of timeless design. These products focus on simplicity, durability and functionality. Perfect for budget-conscious projects, the Classic Series delivers reliable performance without unnecessary embellishments – ideal for creating simple clean spaces.

SIGNATURE SERIES

The Signature Series elevates design with superior quality and refined finishes, thanks to Best Way Stone's innovative DesignLoc® technology. These products combine enhanced durability with style, perfectly balancing aesthetics and functionality. Whether you're designing a residential oasis or a commercial space, the Signature Series delivers exceptional detailed results that stand out without compromising practicality.

PREMIERE SERIES

Best Way Stone's Premiere Series sets the standard for luxury and innovation. Utilizing advanced technologies like NanoBlast™ and ChromaTec™, this features high-end materials and cutting-edge manufacturing techniques. These premium products deliver unparalleled aesthetics and enhanced performance. Designed for those who seek to create truly remarkable spaces, the Premiere Series is where innovation meets elegance.

GEOCERAMICA®

Porcelain + Paver

THE BEST OF BOTH WORLDS

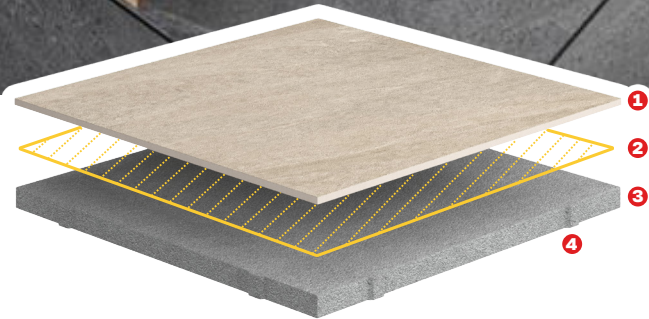

- 1 10 mm Porcelain Tile
- 2 AquaFerm® Bonding Layer
- 3 Stabikorn® Draining Subbase
- 4 Integrated 3 mm Spacer Bars

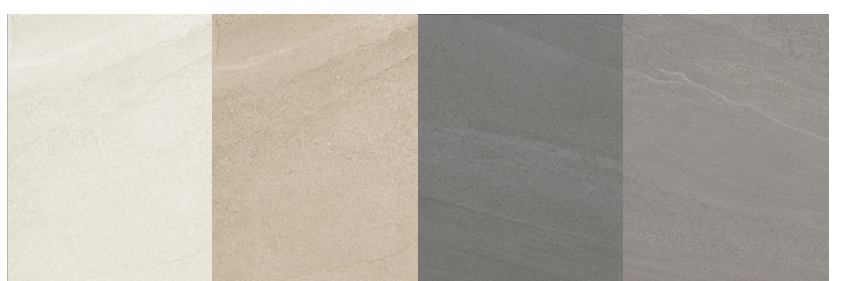

Pearle

Sable

Smoke

Taupe

Best Way Stone is bringing GeoCeramica, the leading European outdoor flooring innovation, exclusively to Canada. GeoCeramica® is a patented luxury outdoor flooring system that combines the timeless beauty of high-quality porcelain tile with the strength and installation benefits of concrete pavers.

Backed by almost a decade of research, testing, and over 90 million square feet installed, GeoCeramica® is the leading choice for a variety of design applications such as patios, pool decks, walkways, entryways, rooftops and public spaces.



For more information on the new and innovative GeoCeramica, please visit geoceramicabws.com



OUTDOOR ELEMENTS COLLECTION

Add warmth and comfort to your patio by gathering around the fire. Our fire pit kits bring a cozy spark to your backyard, creating the perfect spot to relax and unwind.



GARDEN LOCK FIRE PIT



ROCKTON FIRE PIT



SOHO FIRE PIT



ANTICO FIRE PIT



BARNBEAM FIRE PIT

SLABS

- 12 Huntington™
- 13 Ventura™
- 14 Balsam™
- 16 Lyra™
- 18 Trevista® 50 Smooth
- 19 Trevista® 50 Textured
- 20 Adelaide® 50
- 21 Richmond® 50
- 22 Avari™
- 23 Spectra™
- 24 Smooth
- 24 Shot Blast™
- 25 Flagstone™
- 26 Basketweave™
- 27 Standard Press™

PAVERS

- 30 Vanguard™
- 31 Lyra™ 80
- 32 Trevista® 80 Smooth
- 33 Trevista® 80 Textured
- 34 Adelaide® 80
- 35 Richmond® 80
- 36 Manhattan Plank™
- 37 EcoFlow® Permeable Paver
- 38 Corso®
- 39 Napa™
- 40 Prisma™
- 41 Ashford™
- 42 Standard™
- 43 Double Standard™

 Vehicle use permitted

 Eco-Friendly

 Pedestrian traffic only

 Permeable

 Vibrating plate permitted
(rubber membrane required)

WALLS

- 46 Soho™
- 47 Barnbeam™
- 48 Arlington™
- 49 Hazelton™
- 50 Garden Lock™
- 52 Parkwall®
- 54 Ridgewall®
- 56 Stacker
- 57 Ikon™
- 58 Rockton
- 59 Grand Ledge

STEPS, CAPS & CURBS

- 62 Camden™ Step
- 63 Ikon™ Step
- 63 Ridge Step™
- 64 Sopra™ Coping
- 64 Montana™ Cap
- 64 Montana™ Column Cap
- 65 Barollo® 10" Round Edge
- 65 Barollo® 8" Round Edge
- 65 28 x 28 Smooth™ Cap
- 65 Parkwall® Column Cap
- 66 Arlington™ Curb
- 66 Antico® Curb
- 66 Garden Curb™
- 66 Driveway Curb™

 Made with DesignLoc® surface refinement technology

 Enhanced with our factory applied ChromaTec™ protective surface treatment

 Enriched with NanoBlast™ technology

 New for 2026

ENVIRO

- 70 Solar Reflective Rooftop Paver
- 71 EcoFlow® Permeable Paver

PRECAST, & BUILDER PRODUCTS

- 74 Forma™ Steps
- 75 Chimney Caps
- 76 Window Sills
- 76 Keystone
- 76 Heavy Duty Deck Block (4 x 4)
- 77 Splash Pad
- 77 24" Step Riser
- 77 30" Step Riser
- 78 Accessories

RESOURCES

- 80 2026 Colour Chart
- 82 Installation Guide:
Slabs & Pavers
- 83 Installation Guide:
Permeable Paver System
- 84 Installation Guide:
Retaining Walls
- 86 Care & Considerations
- 87 Woodbridge & Uxbridge
Design Centres
- 88 Safety Precautions

SLABS





	mm
12 Huntington™	70
13 Ventura™	60
14 Balsam™	60
16 Lyra™	50
18 Trevista® 50 Smooth	50
19 Trevista® 50 Textured	50
20 Adelaide® 50	50
21 Richmond® 50	50
22 Avari™	50
23 Spectra™	50
24 Smooth	45
24 Shot Blast™	45
25 Flagstone™	45
26 Basketweave™	45
27 Standard Press™	45

PHYSICAL & GEOMETRICAL CHARACTERISTICS

Precast Concrete Paving Slabs

Characteristics	CSA A231.1
Flexural Strength	5.0 MPa (725 psi) min.
Freeze-thaw durability with use of deicing salt	Mass loss (max): 225 g/m ² at 28 cycles Mass loss (max): 500 g/m ² at 49 cycles
Dimensional tolerance ¹	Length and Width: -1.0 mm to +2.0 mm Thickness: +/-3 mm
Concave or Convex Warpage (Up to and including 450 mm)	+2.0 mm
Concave or Convex Warpage (Over 450 mm)	+3.0 mm

1. The dimensional tolerance prior to the application of architectural finishes

HUNTINGTON™

CLASSIC SERIES | 70 mm



UNITS

Random		Small Rectangle	
15.67 x 23.5 x 2.75 in 398 x 597 x 70 mm Units/bundle: 16 Units/layer: 2	15.67 x 15.67 x 2.75 in 398 x 398 x 70 mm Units/bundle: 24 Units/layer: 3	7.83 x 15.67 x 2.75 in 199 x 398 x 70 mm Units/bundle: 24 Units/layer: 3	7.83 x 15.67 x 2.75 in 199 x 398 x 70 mm Units/bundle: 120 Units/layer: 15

BUNDLE OVERVIEW

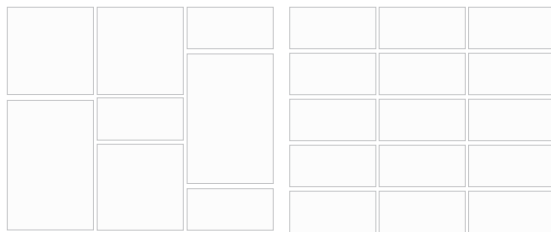

COLOURS



BUNDLE SPECIFICATIONS

	RANDOM	
	IMPERIAL	METRIC
Coverage	102.3 ft ²	9.5 m ²
Weight	3165 lbs	1435 kg
Layers	8	
Coverage per layer	12.8 ft ²	1.19 m ²
Lineal coverage	52.23 / 78.32 ft	15.92 / 23.88 m
Lineal coverage per layer	6.53 / 9.79 ft	1.99 / 2.98 m

	SMALL RECTANGLE	
	IMPERIAL	METRIC
Coverage	100 ft ²	9.29 m ²
Weight	3240 lbs	1470 kg
Layers	8	
Coverage per layer	12.5 ft ²	1.16 m ²
Lineal coverage	78.3 / 156.6 ft	23.87 / 47.76 m
Lineal coverage per layer	9.79 / 19.59 ft	2.98 / 5.97 m

PATTERNS

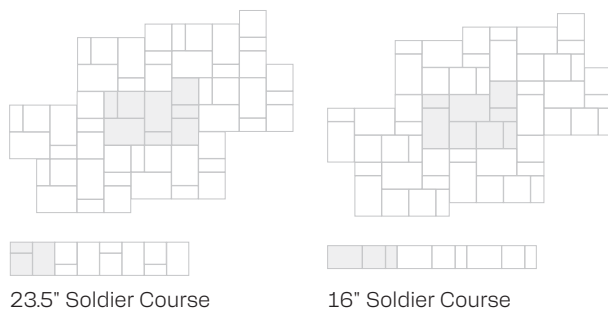

NOTES

Large format slabs with a smooth modern surface. Border or accent with the Huntington™ Small Rectangle or the Corso® paver. Huntington™ Random or Small Rectangle is available for light-duty residential vehicle parking.

Random sold and packaged together in a 2:3:3 ratio.

Plate tamper not recommended.

Small Rectangle sold separately to be used as an accent/border.



UNITS

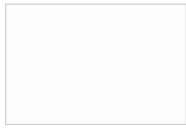

15.67 x 23.5 x 2.36 in
398 x 597 x 60 mm
Units/bundle: 18
Units/layer: 2



15.67 x 15.67 x 2.36 in
398 x 398 x 60 mm
Units/bundle: 27
Units/layer: 3



7.87 x 15.67 x 2.36 in
199 x 398 x 60 mm
Units/bundle: 27
Units/layer: 3

BUNDLE OVERVIEW

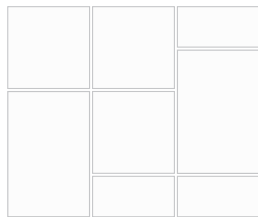

COLOURS



Carrara



Glacier
Creek

BUNDLE SPECIFICATIONS

	IMPERIAL	METRIC
Coverage	115.1 ft ²	10.69 m ²
Weight	3256 lbs	1476 kg
Layers	9	
Coverage per layer	12.79 ft ²	1.19 m ²
Lineal coverage	58.75 / 88.1 ft	17.91 / 26.86 m
Lineal coverage per layer	6.53 / 9.79 ft	1.99 / 2.98 m

NOTES

Large format slabs with subtle textured surface for pedestrian use only. DesignLoc® technology provides a highly refined finish, with integral colouring. Border or accent with Lyra™ or Napa™.

Sold and packaged together in a 2:3:3 ratio.

Plate tamper not recommended.

PATTERNS

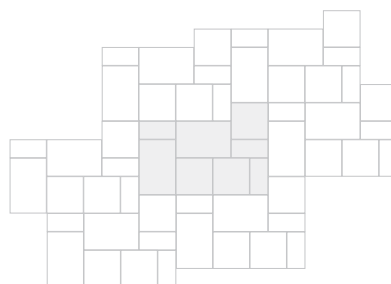
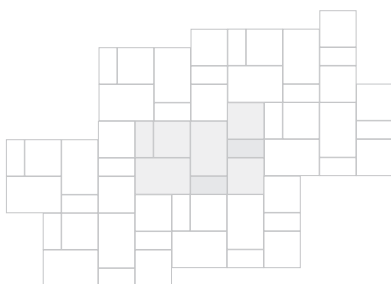

15.67" Soldier Course

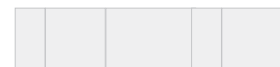

23.5" Soldier Course

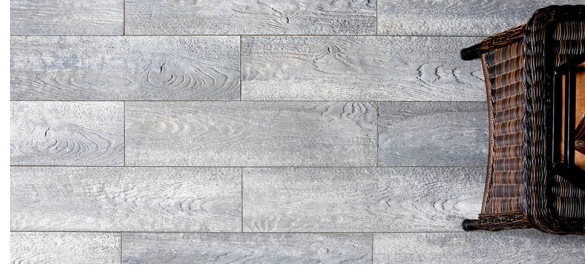

UNIT



31.5 x 7.87 x 2.36 in
 800 x 200 x 60 mm
 Units/bundle: 50
 Units/layer: 5

BUNDLE OVERVIEW

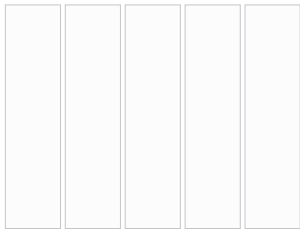

COLOURS



Glacier Creek

Muskoka

Silverbirch

BUNDLE SPECIFICATIONS

	IMPERIAL	METRIC
Coverage	86 ft ²	8 m ²
Weight	2322 lbs	1053 kg
Layers	10	
Coverage per layer	8.6 ft ²	0.8 m ²
Lineal coverage	32.8 / 131.25 ft	10 / 40 m
Lineal coverage per layer	3.28 / 13.1 ft	1 / 4 m

NOTES

For pedestrian use only. Elongated plank format slab with wood grain finish. DesignLoc® technology provides a highly refined and detailed finish, with integral colouring.

Plate tamper not recommended.

PATTERNS

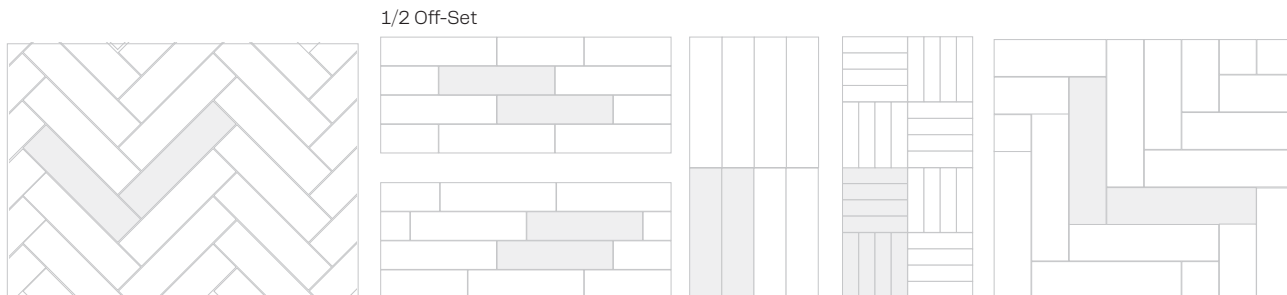

45 Herringbone

1/2 Off-Set

3/4 Off-Set

Tile Joint

Parquet

Herringbone





SIGNATURE & PREMIERE SERIES | 60 mm

UNITS

**12 x 24**

11.81 x 23.62 x 2.36 in
 300 x 600 x 60 mm
 Units/bundle: 54
 Units/layer: 6

BUNDLE SPECIFICATIONS

	IMPERIAL	METRIC
Coverage	104.6 ft ²	9.72 m ²
Weight	3012 lbs	1366.2 kg
Layers	9	
Coverage per layer	11.62 ft ²	1.08 m ²
Lineal coverage	53.15 / 106.29 ft	16.2 / 32.4 m
Lineal coverage per layer	5.91 / 11.81 ft	1.8 / 3.6 m

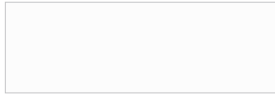
**12 x 36**

11.81 x 35.4 x 2.36 in
 300 x 900 x 60 mm
 Units/bundle: 27
 Units/layer: 3

	IMPERIAL	METRIC
Coverage	78.45 ft ²	7.29 m ²
Weight	2256 lbs	1023.3 kg
Layers	9	
Coverage per layer	8.71 ft ²	0.81 m ²
Lineal coverage	26.57 / 79.72 ft	8.1 / 24.3 m
Lineal coverage per layer	2.95 / 8.86 ft	0.9 / 2.7 m

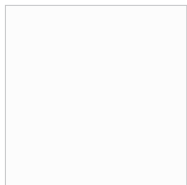
**24 x 24**

23.62 x 23.62 x 2.36 in
 600 x 600 x 60 mm
 Units/bundle: 18
 Units/layer: 2

	IMPERIAL	METRIC
Coverage	69.7 ft ²	6.47 m ²
Weight	1956 lbs	887.2 kg
Layers	9	
Coverage per layer	7.75 ft ²	0.72 m ²
Lineal coverage	35.43 ft	10.8 m
Lineal coverage per layer	3.94 ft	1.2 m

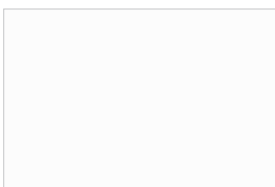
**24 x 36**

23.62 x 35.43 x 2.36 in
 600 x 900 x 60 mm
 Units/bundle: 18
 Units/layer: 2

	IMPERIAL	METRIC
Coverage	104.6 ft ²	9.72 m ²
Weight	2992 lbs	1357 kg
Layers	9	
Coverage per layer	11.62 ft ²	1.08 m ²
Lineal coverage	53.15 / 106.3 ft	16.2 / 32.4 m
Lineal coverage per layer	5.9 / 11.81 ft	1.8 / 3.6 m



BUNDLE OVERVIEW



12 x 24



24 x 24



12 x 36

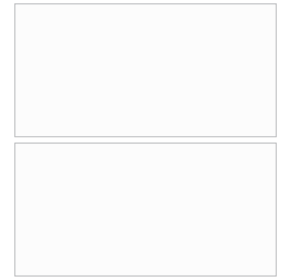

24 x 36

SIGNATURE COLOURS

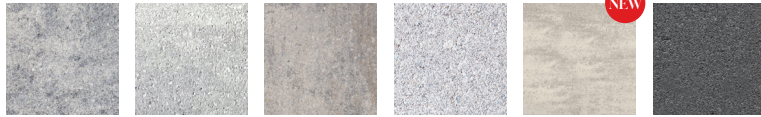

Carrara

Colorado Grey

Glacier Creek

Pearl

Sandstone Taupe

Ultra Black



Ultra Black available in 12 x 24 & 24 x 24.

PREMIERE COLOURS

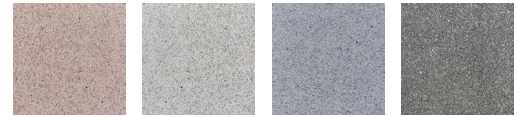

Brightsand

Eclipse

Silverlight

Storm

Premiere colours available in 12x24 and 24x24. All other sizes are special order.

PATTERNS

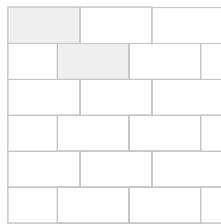

3/4 Off-Set
(Best Practice)

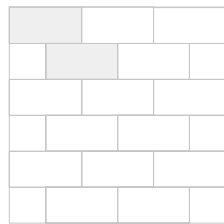

1/2 Off-Set

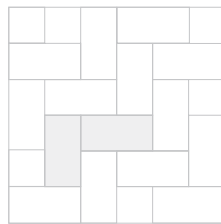

Herringbone

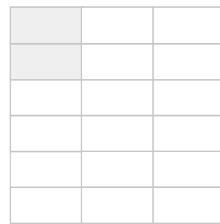

Tile Joint



Tile Joint

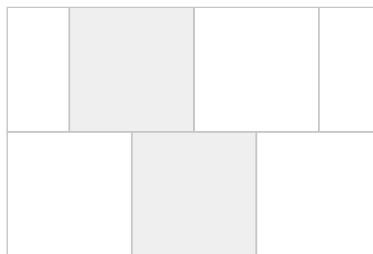

1/2 Off-Set

NOTES

For pedestrian use only. Largeformat slabs with a soft touch surface. Provides a contemporary finish that DesignLoc® technology allows for a highly refined surface, with integral colouring.

When installing slabs on pedestal set, ensure to consider load requirements. Refer to a project engineer for specific considerations.

Plate tamper not recommended.

TREVISTA® 50 SMOOTH

SIGNATURE SERIES | 50 mm



UNITS



19.5 x 13 x 2 in
495 x 330 x 50 mm
Units/bundle: 24
Units/layer: 2

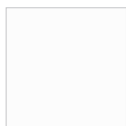

13 x 13 x 2 in
330 x 330 x 50 mm
Units/bundle: 48
Units/layer: 4



6.5 x 13 x 2 in
165 x 330 x 50 mm
Units/bundle: 48
Units/layer: 4

BUNDLE OVERVIEW

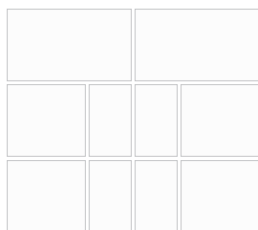

COLOURS

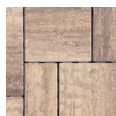

Autumn Hill



Carrara



Glacier
Creek



Grey Mix



Sandstone
Taupe

BUNDLE SPECIFICATIONS

	IMPERIAL	METRIC
Coverage	125.4 ft ²	11.64 m ²
Weight	3010 lbs	1365 kg
Layers	12	
Coverage per layer	10.45 ft ²	0.97 m ²
Lineal coverage	78 / 117 ft	23.76 / 35.64 m
Lineal coverage per layer	6.5 / 9.75 ft	1.98 / 2.97 m

NOTES

For pedestrian use only. Random format slabs with a smooth modern finish. DesignLoc® technology provides a highly refined surface, with integral colouring. Border or accent with Adelaide® 50 or Richmond® 50.

Sold and packaged together in a 1:2:2 ratio.

Plate tamper not recommended.

PATTERNS

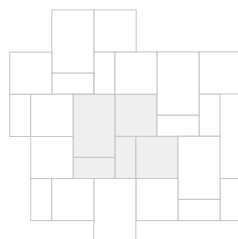
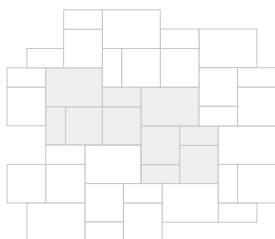
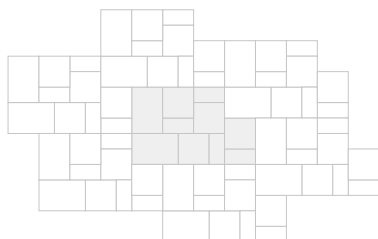

13" Soldier Course

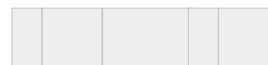

19.5" Soldier Course

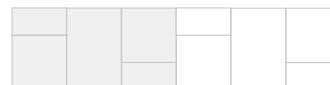

TREVISTA® 50 TEXTURED

SIGNATURE SERIES | 50 mm



UNITS

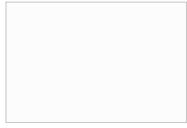

19.5 x 13 x 2 in
495 x 330 x 50 mm
Units/bundle: 24
Units/layer: 2

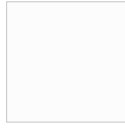

13 x 13 x 2 in
330 x 330 x 50 mm
Units/bundle: 48
Units/layer: 4



6.5 x 13 x 2 in
165 x 330 x 50 mm
Units/bundle: 48
Units/layer: 4

BUNDLE OVERVIEW

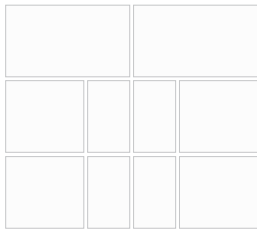

COLOURS

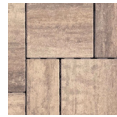

Autumn Hill



Carrara



Glacier
Creek

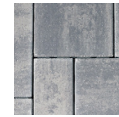

Grey Mix

BUNDLE SPECIFICATIONS

	IMPERIAL	METRIC
Coverage	125.4 ft ²	11.64 m ²
Weight	3010 lbs	1365 kg
Layers	12	
Coverage per layer	10.45 ft ²	0.97 m ²
Lineal coverage	78 / 117 ft	23.76 / 35.64 m
Lineal coverage per layer	6.5 / 9.75 ft	1.98 / 2.97 m

NOTES

For pedestrian use only. Random format slabs with a natural textured finish. DesignLoc® technology provides a highly refined surface, with integral colouring. Border or accent with Adelaide® 50 or Richmond® 50.

Sold and packaged together in a 1:2:2 ratio.

Plate tamper not recommended.

PATTERNS

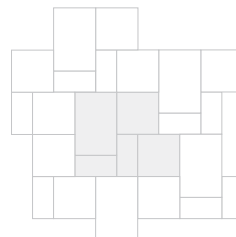
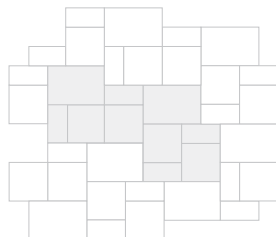
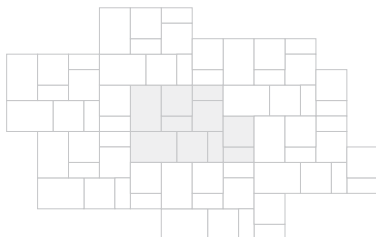

13" Soldier Course

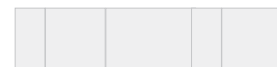

19.5" Soldier Course



ADELAIDE[®] 50



SIGNATURE SERIES | 50 mm



UNIT



6.5 x 13 x 2 in
 165 x 330 x 50 mm
 Units/bundle: 252
 Units/layer: 21

BUNDLE OVERVIEW

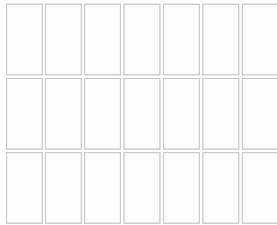

COLOURS



Glacier
Creek

Grey

Ultra Black

BUNDLE SPECIFICATIONS

	IMPERIAL	METRIC
Coverage	1476 ft ²	13.65 m ²
Weight	3542 lbs	1606.5 kg
Layers	12	
Coverage per layer	12.3 ft ²	1.14 m ²
Lineal coverage	136.5 / 273 ft	41.55 / 83.1 m
Lineal coverage per layer	11.38 / 22.75 ft	3.46 / 6.93 m

PATTERNS

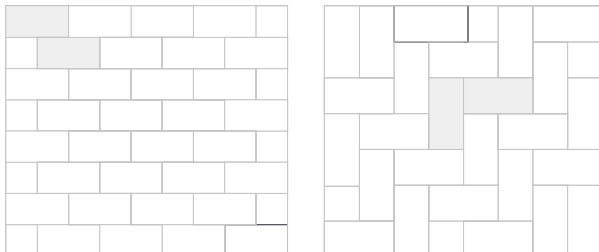

NOTES

For pedestrian use only. Can be used on its own or as a modern accent and/or border for 50 mm line of slabs. The smooth surface provides a contemporary finish.

Plate tamper not recommended.

RICHMOND[®] 50



SIGNATURE SERIES | 50 mm



UNIT



6.5 x 13 x 2 in
165 x 330 x 50 mm
Units/bundle: 252
Units/layer: 21

BUNDLE OVERVIEW

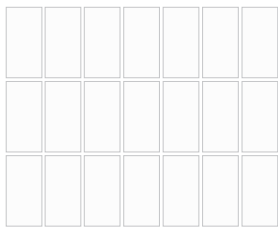

COLOURS



Glacier
Creek

Grey Mix

Ultra Black

BUNDLE SPECIFICATIONS

	IMPERIAL	METRIC
Coverage	147.6 ft ²	13.65 m ²
Weight	3542 lbs	1606.5 kg
Layers	12	
Coverage per layer	12.3 ft ²	1.14 m ²
Lineal coverage	136.5 / 273 ft	41.55 / 83.1 m
Lineal coverage per layer	11.38 / 22.75 ft	3.46 / 6.93 m

PATTERNS

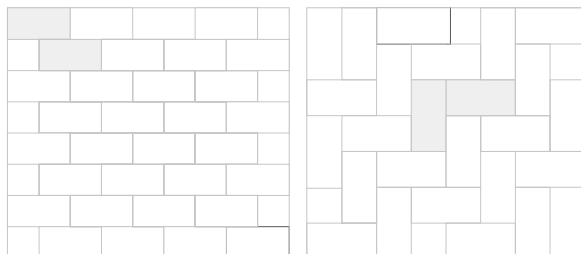

NOTES

For pedestrian use only. Can be used on its own, or as an accent and/or border for 50 mm line of slabs.

Plate tamper not recommended

AVARI™



PREMIERE SERIES | 50 mm



UNIT



28 x 14 x 2 in
 710 x 355 x 50 mm
 Units/bundle: 30
 Units/layer: 3

BUNDLE OVERVIEW



COLOURS



Carrara
(DesignLoc®
Only)



Glacier
Creek



Grey
Mix

BUNDLE SPECIFICATIONS

	IMPERIAL	METRIC
Coverage	81.6 ft ²	7.58 m ²
Weight	1921 lbs	871.4 kg
Layers	10	
Coverage per layer	8.16 ft ²	0.76 m ²
Lineal coverage	35 / 70 ft	10.7 / 21.3 m
Lineal coverage per layer	3.5 / 7 ft	1.07 / 2.13 m

PATTERNS

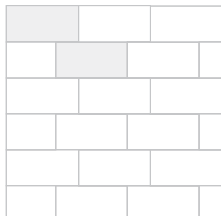

3/4 Off-Set
(Best Practice)

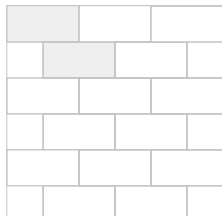

1/2 Off-Set

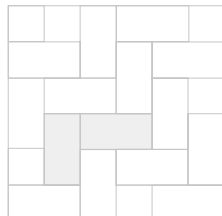

Herringbone

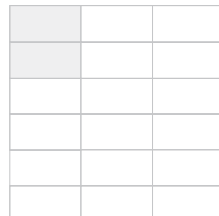

Tile Joint

NOTES

For pedestrian use only. Large format rectangular slab with soft touch surface. Contemporary, smooth finish. DesignLoc® technology provides a highly refined finish, protected and enhanced by ChromaTec®.

Plate tamper not recommended.



UNIT

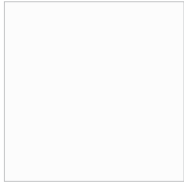

23.62 x 23.62 x 2 in
600 x 600 x 50 mm
Units/bundle: 20

BUNDLE OVERVIEW



COLOURS



BUNDLE SPECIFICATIONS

	IMPERIAL	METRIC
Coverage	77.49 ft ²	7.2 m ²
Weight	1852 lbs	840 kg
Units	20	
Coverage per unit	3.87 ft ²	0.36 m ²
Lineal coverage	39.37 ft	12 m
Lineal coverage per unit	1.97 ft	0.6 m

PATTERNS

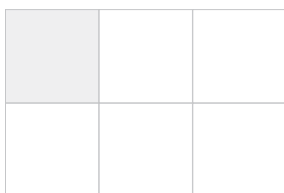

Tile Joint

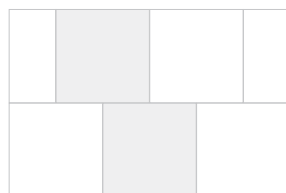

1/2 Off-Set

NOTES

Large format slab that adds a contemporary finish to any patio, poolside, walkway or rooftop application. Sold in full bundles only. For pedestrian use only. When installing slabs on a pedestal set, ensure to consider load requirements. Refer to a project engineer for specific considerations.

Plate tamper not recommended.

60 mm available by special order.

SMOOTH & SHOT BLAST

CLASSIC SERIES | 45 mm (50 & 60 mm)



UNITS

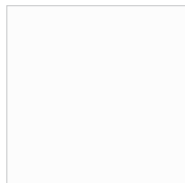

Smooth
23.62 x 23.62 x 1.77 in
600 x 600 x 45 mm
Units/bundle: 24

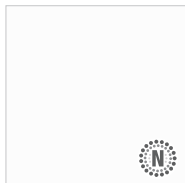

Shot Blast
23.62 x 23.62 x 1.77 in
600 x 600 x 45 mm
Units/bundle: 24

BUNDLE OVERVIEW



COLOURS

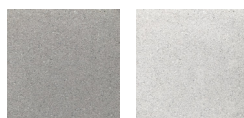

Grey

White

BUNDLE SPECIFICATIONS

	IMPERIAL	METRIC
Coverage	92.99 ft ²	8.64 m ²
Weight	2011.2 lbs	912 kg
Units	24	
Coverage per unit	3.87 ft ²	0.36 m ²
Lineal coverage	47.24 ft	14.4 m
Lineal coverage per unit	1.97 ft	0.6 m

PATTERNS

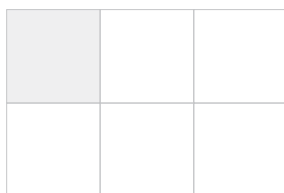

Tile Joint

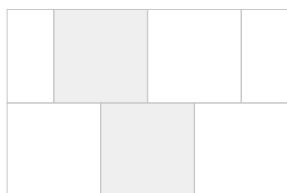

1/2 Off-Set

NOTES

A large format slab with a smooth surface finish. The 24x24 Smooth slab brings a modern touch to a traditional paving and rooftop terrace slab. Sold in full bundles only. When installing slabs on a pedestal set, ensure to consider load requirements. Refer to a project engineer for specific considerations.

Plate tamper not recommended.

50 mm & 60 mm available by special order.

FLAGSTONE™

CLASSIC SERIES | 45 mm



UNIT



23.62 x 23.62 x 1.77 in
600 x 600 x 45 mm
Units/bundle: 24

BUNDLE OVERVIEW



COLOURS

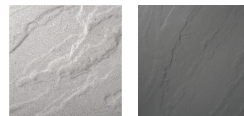

Grey

Nightfall

BUNDLE SPECIFICATIONS

	IMPERIAL	METRIC
Coverage	92.99 ft ²	8.64 m ²
Weight	2011.2 lbs	912 kg
Units	24	
Coverage per unit	3.87 ft ²	0.36 m ²
Lineal coverage	47.24 ft	14.4 m
Lineal coverage per unit	1.97 ft	0.6 m

PATTERNS

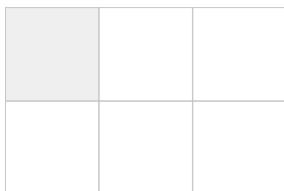

Tile Joint

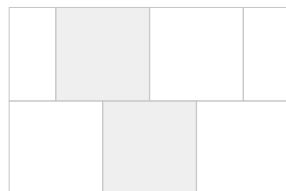

1/2 Off-Set

NOTES

For pedestrian use only. Naturally inspired flagstone finish. Classic slab, does not include spacer bars. Sold in full bundles only.

When installing slabs on a pedestal set, ensure to consider load requirements. Refer to a project engineer for specific considerations.

Plate tamper not permitted.

BASKETWEAVE™

CLASSIC SERIES | 45 mm (50 & 60 mm)



UNITS

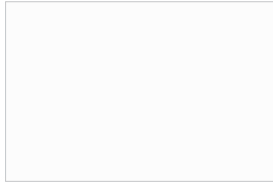

23.62 x 29.52 x 1.77 in
600 x 750 x 45 mm
Units/bundle: 24



23.62 x 23.62 x 1.77 in
600 x 600 x 45 mm
Units/bundle: 24

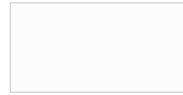

11.81 x 23.62 x 1.77 in
300 x 600 x 45 mm
Units/bundle: 72

COLOUR



White

NOTES

For pedestrian use only. Classic slabs do not include spacer bars. All sizes sold and packaged separately. Sold in full bundles only. The use of a plate tamper is not permitted.

When installing slabs on a pedestal set, ensure to consider load requirements. Refer to a project engineer for specific considerations.

50 mm & 60 mm available by special order.

BUNDLE SPECIFICATIONS

	24 x 30 IMPERIAL		24 x 24 IMPERIAL		12 x 24 IMPERIAL	
		METRIC		METRIC		METRIC
Coverage	116.22 ft ²	10.8 m ²	92.99 ft ²	8.64 m ²	139.48 ft ²	12.96 m ²
Weight	2539.7 lbs	1152 kg	2011.2 lbs	912 kg	2880 lbs	1305.36 kg
Units	24		24		72	
Coverage per unit	4.84 ft ²	0.45 m ²	3.87 ft ²	0.36 m ²	1.94 ft ²	0.18 m ²
Lineal coverage	47.24 / 59.04 ft	14.4 / 18 m	47.24 ft	14.4 m	70.86 / 141.72 ft	21.6 / 43.2 m
Lineal coverage per unit	1.97 / 2.46 ft	0.6 / 0.75 m	1.97 ft	0.6 m	0.98 / 1.97 ft	0.3 / 0.6 m

SPECIAL ORDER BUNDLE SPECIFICATIONS

	24 x 24 (50 mm) IMPERIAL		24 x 24 (60 mm) IMPERIAL	
		METRIC		METRIC
Coverage	77.49 ft ²	7.2 m ²	69.7 ft ²	6.47 m ²
Weight	1852 lbs	840 kg	1956 lbs	887.2 kg
Units	20		18	
Coverage per unit	3.87 ft ²	0.36 m ²	3.87 ft ²	0.36 m ²
Lineal coverage	39.37 ft	12 m	35.43 ft	10.8 m
Lineal coverage per unit	1.97 ft	0.6 m	1.97 ft	0.6 m

STANDARD PRESS™

CLASSIC SERIES | 45 mm



UNIT

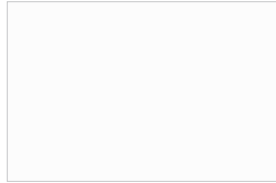

23.62 x 29.52 x 1.77 in
600 x 750 x 45 mm
Units/bundle: 24



23.62 x 23.62 x 1.77 in
600 x 600 x 45 mm
Units/bundle: 24

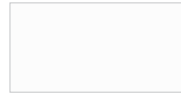

11.81 x 23.62 x 1.77 in
300 x 600 x 45 mm
Units/bundle: 72



15.75 x 15.75 x 1.77 in
400 x 400 x 45 mm
Units/bundle: 60

COLOUR



Charcoal (24x24 Only) Grey (All Sizes) Red (16x16 & 24x24)

NOTES

For pedestrian use only. Classic slabs do not include spacer bars. All sizes sold and packaged separately. Sold in full bundles only. The use of a plate tamper is not permitted.

When installing slabs on a pedestal set, ensure to consider load requirements. Refer to a project engineer for specific considerations.

BUNDLE SPECIFICATIONS

24 x 30

	IMPERIAL	METRIC
Coverage	116.22 ft ²	10.8 m ²
Weight	2539.7 lbs	1152 kg
Units	24	
Coverage per unit	4.84 ft ²	0.45 m ²
Lineal coverage	47.24 / 59.04 ft	14.4 / 18 m
Lineal coverage per unit	1.97 / 2.46 ft	0.6 / 0.75 m

24 x 24

	IMPERIAL	METRIC
Coverage	92.99 ft ²	8.64 m ²
Weight	2011.2 lbs	912 kg
Units	24	
Coverage per unit	3.87 ft ²	0.36 m ²
Lineal coverage	47.24 ft	14.4 m
Lineal coverage per unit	1.97 ft	0.6 m

12 x 24

	IMPERIAL	METRIC
Coverage	139.48 ft ²	12.96 m ²
Weight	2880 lbs	1305.36 kg
Units	72	
Coverage per unit	1.94 ft ²	0.18 m ²
Lineal coverage	70.86 / 141.72 ft	21.6 / 43.2 m
Lineal coverage per unit	0.98 / 1.97 ft	0.3 / 0.6 m

16 x 16

	IMPERIAL	METRIC
Coverage	103 ft ²	9.6 m ²
Weight	2070 lbs	939 kg
Units	60	
Coverage per unit	1.72 ft ²	0.16 m ²
Lineal coverage	78.74 ft	24 m
Lineal coverage per unit	1.31 ft	0.4 m



PAVERS



	mm
30 Vanguard™	100
31 Lyra™ 80	80
32 Trevista® 80 Smooth	80
33 Trevista® 80 Textured	80
34 Adelaide® 80	80
35 Richmond® 80	80
36 Manhattan Plank™	80
37 EcoFlow® 80 Permeable	80
38 Corso®	70
39 Napa™	60
40 Prisma™	60
41 Ashford™	60
42 Standard™	60 & 80
43 Double Standard™	60

PHYSICAL & GEOMETRICAL CHARACTERISTICS

Precast Concrete Pavers

Characteristics	CSA A231.2
Compressive Strength	50 MPa (7252 psi) min.
Freeze-thaw durability with use of deicing salt	Mass loss (max): 225 g/m ² at 28 cycles Mass loss (max): 500 g/m ² at 49 cycles
Dimensional tolerance ¹	Length and Width: -1.0 mm to +2.0 mm Thickness: +/- 3mm

1. The dimensional tolerance prior to the application of architectural finishes



UNITS

8 x 24

4 x 12

4 x 12 Edge Surface

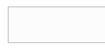

7.87 x 23.63 x 3.94 in
200 x 600 x 100 mm
Units/bundle: 48
Units/layer: 8

3.94 x 11.81 x 3.94 in
100 x 300 x 100 mm
Units/bundle: 216
Units/layer: 36

3.94 x 11.81 x 3.94 in
100 x 300 x 100 mm
Units/bundle: 216
Units/layer: 36

BUNDLE OVERVIEW

4 x 12

8 x 24

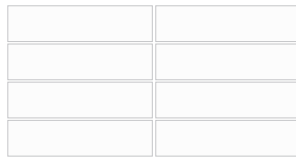
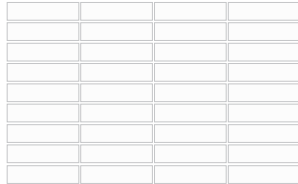

COLOURS

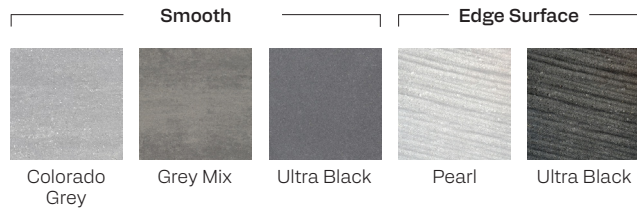

BUNDLE SPECIFICATIONS

8 x 24	IMPERIAL	METRIC
Coverage	62 ft ²	5.76 m ²
Weight	2825.4 lbs	1281.6 kg
Layers	6	
Coverage per layer	10.33 ft ²	0.96 m ²
Lineal coverage	31.48 / 94.52 ft	9.8 / 28.8 m
Lineal coverage per layer	5.25 / 15.75 ft	1.6 / 4.8 m

4 x 12 / Edge Surface	IMPERIAL	METRIC
Coverage	69.8 ft ²	6.48 m ²
Weight	3238 lbs	1469 kg
Layers	6	
Coverage per layer	11.63 ft ²	1.09 m ²
Lineal coverage	70.92 / 212.58 ft	21.6 / 64.8 m
Lineal coverage per layer	11.82 / 35.43 ft	3.6 / 10.8 m

PATTERNS

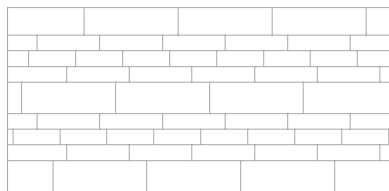

4" x 12" / 8" x 24" Mix

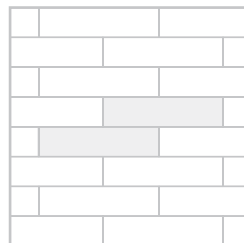

Running Bond

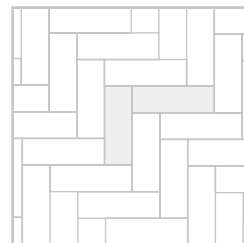

Herringbone

NOTES

Designed for any commercial space, Vanguard combines a contemporary finish, with durability and comfort. Mix and match surface finishes and colours to create a dynamic and engaging space.

4 x 12 Edge Surface available by special order only.

LYRA™ 80



SIGNATURE SERIES | 80 mm



UNIT

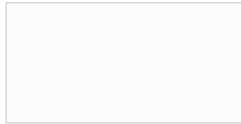

31.50 x 15.75 x 3.15 in
 800 x 400 x 80 mm
 Units/bundle: 24
 Units/layer: 3

BUNDLE OVERVIEW



COLOURS



Carrara



Colorado Grey



Glacier Creek



Sandstone Taupe

BUNDLE SPECIFICATIONS

	IMPERIAL	METRIC
Coverage	82.7 ft ²	7.68 m ²
Weight	3012 lbs	1366.22 kg
Layers	8	-
Coverage per layer	10.34 ft ²	0.96 m ²
Lineal coverage	35.44 / 63 ft	9.6 / 19.2 m
Lineal coverage per layer	3.94 / 7.88 ft	1.2 / 2.4 m

PATTERNS

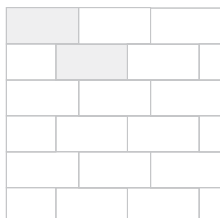

3/4 Off-Set
(Best Practice)

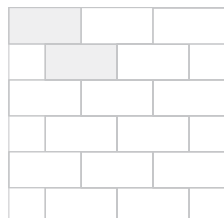

1/2 Off-Set

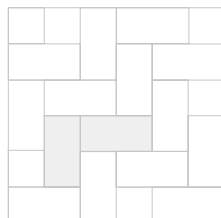

Herringbone

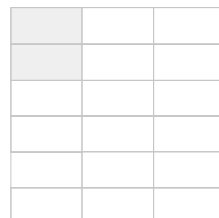

Tile Joint

NOTES

For pedestrian and/or vehicular use. Lyra™ 80 is a large format paver with a smooth modern surface. The DesignLoc® surface technology provides a highly refined, durable and colour enriched surface.

Border or accent with Adelaide® 80 or Richmond® 80.

TREVISTA® 80 SMOOTH



SIGNATURE SERIES | 80 mm



UNITS



19.5 x 13 x 3.15 in
495 x 330 x 80 mm
Units/bundle: 16
Units/layer: 2

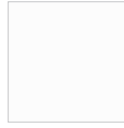

13 x 13 x 3.15 in
330 x 330 x 80 mm
Units/bundle: 32
Units/layer: 4



6.5 x 13 x 3.15 in
165 x 330 x 80 mm
Units/bundle: 32
Units/layer: 4

BUNDLE OVERVIEW

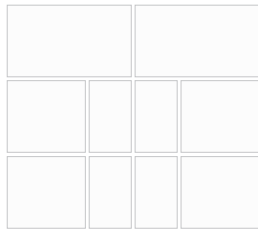

COLOURS



Autumn Hill

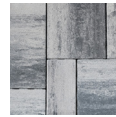

Carrara



Glacier
Creek



Grey Mix



Sandstone
Taupe

BUNDLE SPECIFICATIONS

	IMPERIAL	METRIC
Coverage	83.6 ft ²	7.76 m ²
Weight	3077 lbs	1395.85 kg
Layers	8	
Coverage per layer	10.45 ft ²	0.97 m ²
Lineal coverage	52 / 78 ft	15.85 / 23.77 m
Lineal coverage per layer	6.5 / 9.75 ft	1.98 / 2.97 m

NOTES

For pedestrian and/or vehicular use. Trevista® 80 Smooth is a large format paver with a smooth modern surface. Sold and packaged together in a 1:2:2 ratio. The DesignLoc® surface technology provides a highly refined, colour enriched finish.

Border or accent with Adelaide® 80 or Richmond® 80.

PATTERNS

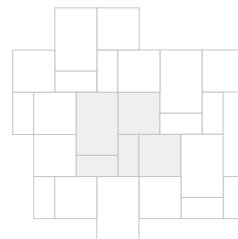
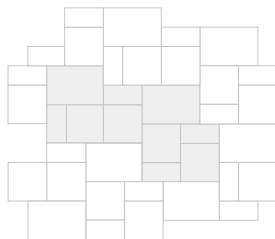
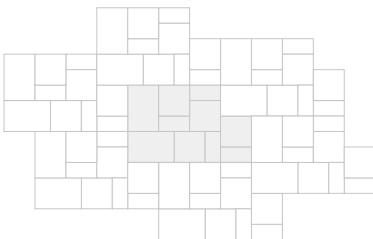

13" Soldier Course

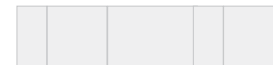

19.5" Soldier Course

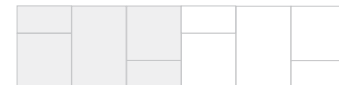

TREVISTA® 80 TEXTURED

SIGNATURE SERIES | 80 mm



UNITS

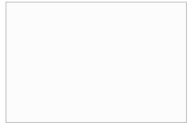

19.5 x 13 x 3.15 in
495 x 330 x 80 mm
Units/bundle: 16
Units/layer: 2



13 x 13 x 3.15 in
330 x 330 x 80 mm
Units/bundle: 32
Units/layer: 4



6.5 x 13 x 3.15 in
165 x 330 x 80 mm
Units/bundle: 32
Units/layer: 4

BUNDLE OVERVIEW

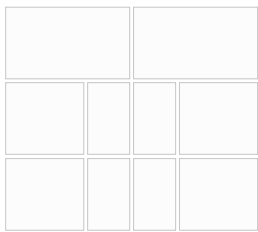

COLOURS

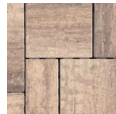

Autumn Hill



Carrara



Glacier
Creek



Grey Mix

BUNDLE SPECIFICATIONS

	IMPERIAL	METRIC
Coverage	83.6 ft ²	7.76 m ²
Weight	3077 lbs	1395.85 kg
Layers	8	
Coverage per layer	10.45 ft ²	0.97 m ²
Lineal coverage	52 / 78 ft	15.85 / 23.77 m
Lineal coverage per layer	6.5 / 9.75 ft	1.98 / 2.97 m

NOTES

For pedestrian and/or vehicular use. Trevista® 80 Textured is a large format paver with an elegant and traditional texture. Sold and packaged together in a 1:2:2 ratio. The DesignLoc® surface technology provides a highly refined, colour enriched finish.

Border or accent with Adelaide® 80 or Richmond® 80.

PATTERNS

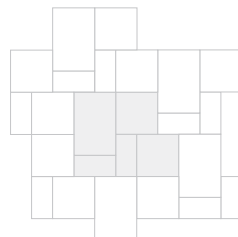
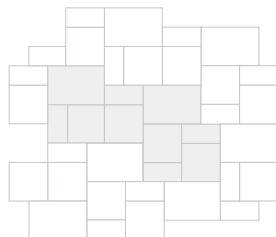
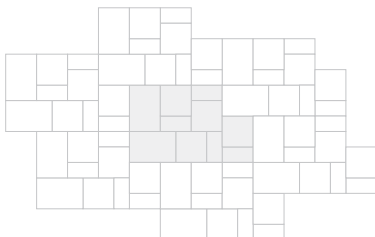

13" Soldier Course

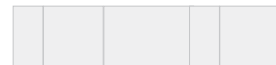

19.5" Soldier Course

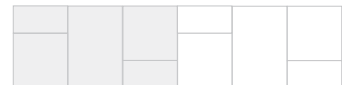

ADELAIDE[®] 80



SIGNATURE SERIES | 80 mm



UNIT



6.5 x 13 x 3.15 in
 165 x 330 x 80 mm
 Units/bundle: 168
 Units/layer: 21

BUNDLE OVERVIEW

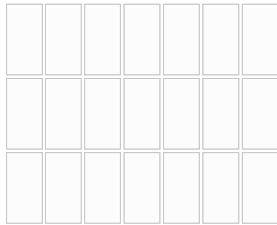

COLOURS



Glacier
Creek

Grey

Ultra Black

BUNDLE SPECIFICATIONS

	IMPERIAL	METRIC
Coverage	98.4 ft ²	9.1 m ²
Weight	3622 lbs	1643 kg
Layers	8	
Coverage per layer	12.3 ft ²	1.14 m ²
Lineal coverage	91 / 182 ft	27.7 / 55.4 m
Lineal coverage per layer	11.38 / 22.75 ft	3.46 / 6.93 m

PATTERNS

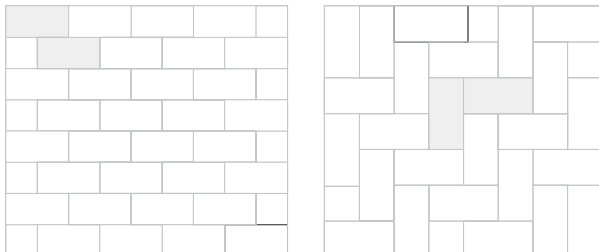

NOTES

For pedestrian and/or vehicular usage.

Can be used on its own or as a modern accent and/or border for the Trevista[®] 80 pavers.

The smooth surface provides a contemporary finish.

RICHMOND[®] 80

SIGNATURE SERIES | 80 mm



UNIT

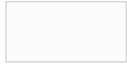

6.5 x 13 x 3.15 in
165 x 330 x 80 mm
Units/bundle: 168
Units/layer: 21

BUNDLE OVERVIEW

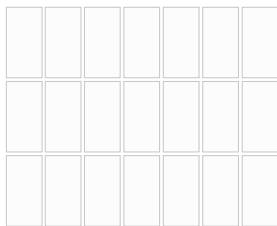

COLOURS



Glacier
Creek

Grey Mix

Ultra Black

BUNDLE SPECIFICATIONS

	IMPERIAL	METRIC
Coverage	98.4 ft ²	9.1 m ²
Weight	3622 lbs	1643 kg
Layers	8	
Coverage per layer	12.3 ft ²	1.14 m ²
Lineal coverage	91 / 182 ft	27.7 / 55.4 m
Lineal coverage per layer	11.38 / 22.75 ft	3.46 / 6.93 m

PATTERNS

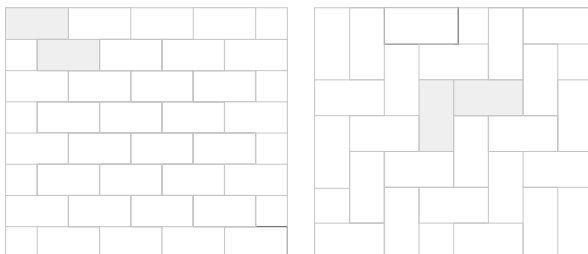

NOTES

For pedestrian and/or vehicular usage.

Can be used on its own, or as an accent and/or border for the Trevista[®] 80 pavers.

Subtle textured surface provides striking interest.







MANHATTAN PLANK™



SIGNATURE SERIES | 80 mm | SPECIAL ORDER ITEM



UNITS

						
A	B	C	D	E	F	G
6.50 x 4.33 x 3.15 in 165 x 110 x 80 mm	10.83 x 4.33 x 3.15 in 275 x 110 x 80 mm	12.99 x 4.33 x 3.15 in 330 x 110 x 80 mm	17.32 x 4.33 x 3.15 in 440 x 110 x 80 mm	8.66 x 6.50 x 3.15 in 220 x 165 x 80 mm	12.99 x 6.50 x 3.15 in 330 x 165 x 80 mm	17.32 x 6.50 x 3.15 in 440 x 165 x 80 mm
Units/bundle: 32 Units/layer: 4	Units/bundle: 32 Units/layer: 4	Units/bundle: 32 Units/layer: 4	Units/bundle: 32 Units/layer: 4	Units/bundle: 32 Units/layer: 4	Units/bundle: 16 Units/layer: 2	Units/bundle: 16 Units/layer: 2

BUNDLE OVERVIEW

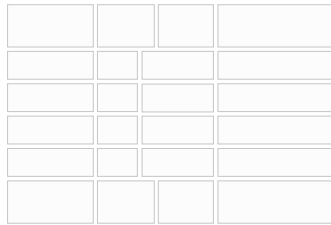

COLOURS



BUNDLE SPECIFICATIONS

	IMPERIAL	METRIC
Coverage	80 ft ²	7.44 m ²
Weight	2944.5 lbs	1338 kg
Layers	8	
Coverage per layer	10 ft ²	0.93 m ²
Lineal coverage (A - D)	127 ft	38.72 m
Lineal coverage per layer (A - D)	15.875 ft	4.84 m
Lineal coverage (E - G)	63.5 ft	19.36 m
Lineal coverage per layer (E - G)	7.94 ft	2.42 m

PATTERNS

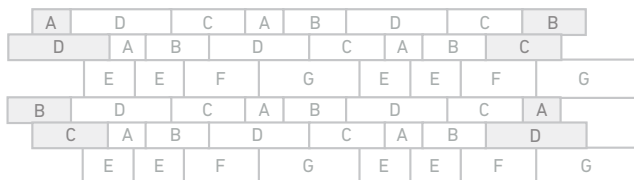

NOTES

Provides a contemporary linear finish. Manhattan Plank™ is 80 mm thick, ideal for any application. Install in a ratio of 2 (4.33") rows to every 1 (6.5") row.

All sizes are sold and packaged together.

The DesignLoc® surface technology provides a highly refined, colour enriched finish.

ECOFLOW® PERMEABLE PAVER

SIGNATURE SERIES | 80 mm



UNIT



4.92 x 9.84 x 3.14 in
125 x 250 x 80 mm
Units/bundle: 256
Units/layer: 32

Joint Width: 7 mm (9/32")
% Surface Opening: 8.4%
Infiltration Rate: mm/h 22,962

BUNDLE OVERVIEW

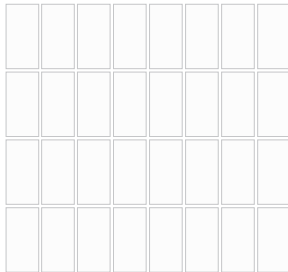

COLOURS



Colorado Grey

Grey

Grey Mix

BUNDLE SPECIFICATIONS

	IMPERIAL	METRIC
Coverage	86.08 ft ²	8 m ²
Weight	2900.9 lbs	1315.8 kg
Layers	8	
Coverage per layer	10.76 ft ²	1.0 m ²
Lineal coverage	104.96 / 209.92 ft	32 / 64 m
Lineal coverage per layer	13.12 / 26.24 ft	4 / 8 m



PATTERN

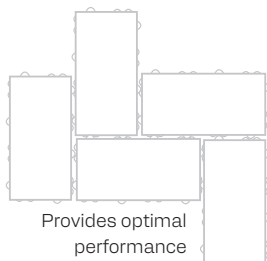

NOTES

EcoFlow® delivers a clean, modern and sophisticated aesthetic. Manufactured using DesignLoc® technology, the two-step manufacturing process creates a refined top layer while reinforcing a strong, durable base. EcoFlow® is designed to have strategic spacer bars that create greater infiltration between units, enabling efficient water drainage meeting CMHA specifications.

For pedestrian and/or vehicular use.



UNITS



9.96 x 5.24 x 2.75 in
253 x 133 x 70 mm
Units/bundle: 112
Units/layer: 14

7.60 x 5.24 x 2.75 in
193 x 133 x 70 mm
Units/bundle: 112
Units/layer: 14

5.24 x 5.24 x 2.75 in
133 x 133 x 70 mm
Units/bundle: 112
Units/layer: 14

BUNDLE OVERVIEW

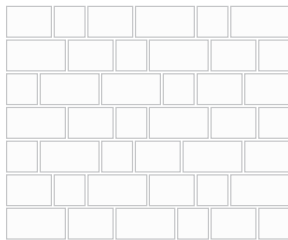

COLOURS



Grey Mix

Ultra Black

BUNDLE SPECIFICATIONS

	IMPERIAL	METRIC
Coverage	94 ft ²	8.74 m ²
Weight	2907 lbs	1318.78 kg
Layers	8	
Coverage per layer	11.75 ft ²	1.09 m ²
Lineal coverage	212.8 ft	64.85 m
Lineal coverage per layer	26.6 ft	8.11 m

NOTES

For pedestrian and/or vehicular use. Corso[®] provides a European cobblestone aesthetic with a highly detailed texture. All sizes are sold and packaged together in a 1:1:1 ratio.

Provides a great border or accent for the Huntington 70mm.

PATTERN

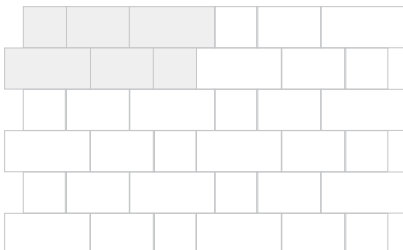



UNITS



2.36 x 9.45 x 2.36 in
 60 x 240 x 60 mm
 Units/bundle: 585
 Units/layer: 65

BUNDLE OVERVIEW

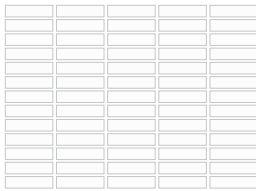

COLOURS

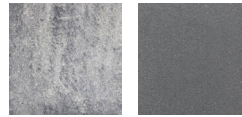

Carrara Ultra Black

BUNDLE SPECIFICATIONS

	IMPERIAL	METRIC
Coverage	90.6 ft ²	8.42 m ²
Weight	2540.7 lbs	1152.5 kg
Layers	9	
Coverage per layer	10.07 ft ²	0.936 m ²
Lineal coverage	115.02 / 460.7 ft	35.1 / 140 m
Lineal coverage per layer	12.78 / 51.19 ft	3.9 / 15.6 m

NOTES

For pedestrian and/or vehicular use. Provides a classic smooth surface with subtle edges. Herringbone pattern provides contemporary finish.

Can use independently or provides an ideal accent/border stone for 60 mm slabs.

PATTERNS

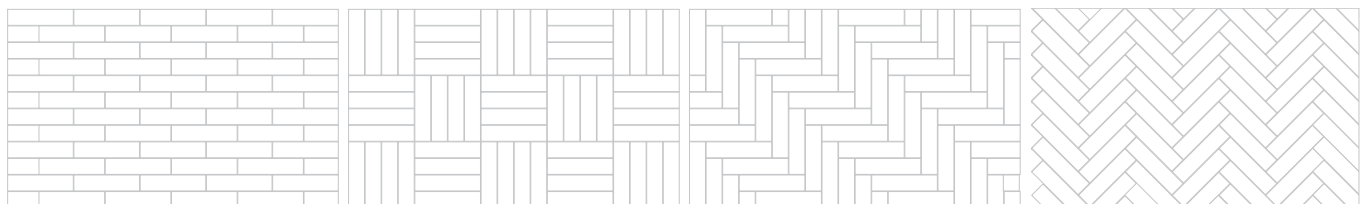

1/2 Off-Set

Parquet

Herringbone

45° Herringbone

PRISMA™



SIGNATURE SERIES | 60 mm



UNITS



7.76 x 8.96 x 2.36 in
 197 x 227.5 x 60 mm
 Units/bundle: 162
 Units/layer: 18

BUNDLE OVERVIEW

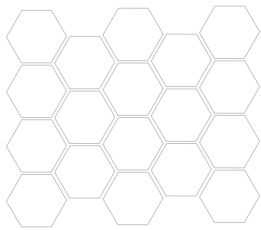

COLOURS

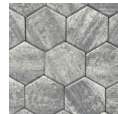

Carrara

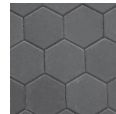

Ultra Black

BUNDLE SPECIFICATIONS

	IMPERIAL	METRIC
Coverage	58.57 ft ²	5.44 m ²
Weight	1620 lbs	735 kg
Layers	9	
Coverage per layer	6.51 ft ²	0.60 m ²

PATTERNS

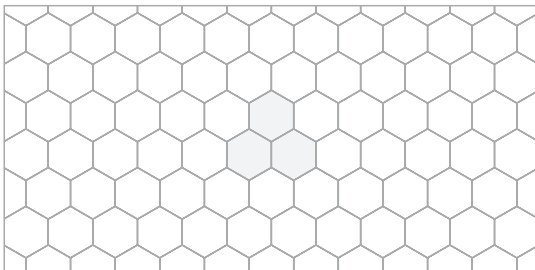

NOTES

The Prisma paver blends timeless aesthetics with a modern twist, ideal for cutting-edge hardscape designs. Its elongated hexagonal form brings a distinctive geometric flair to landscaping, seamlessly integrating with various contemporary outdoor areas. Elevating projects, Prisma introduces chic style and dimension.



UNITS

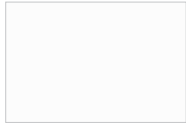

13 x 8.66 x 2.36 in
330 x 220 x 60 mm
Units/bundle: 54
Units/layer: 6



8.66 x 8.66 x 2.36 in
220 x 220 x 60 mm
Units/bundle: 72
Units/layer: 8



8.66 x 4.33 x 2.36 in
220 x 110 x 60 mm
Units/bundle: 54
Units/layer: 6

BUNDLE OVERVIEW



COLOURS



Colorado
Grey

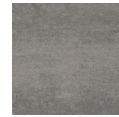

Grey Mix



Summer
Mist

BUNDLE SPECIFICATIONS

	IMPERIAL	METRIC
Coverage	93.75 ft ²	8.71 m ²
Weight	2628 lbs	1192 kg
Layers	9	
Coverage per layer	10.42 ft ²	0.97 m ²
Lineal coverage	130 ft	39.6 m
Lineal coverage per layer	14.44 ft	4.4 m

NOTES

For pedestrian and/or vehicular use. Provides a classic smooth surface with subtle edges. Install in a 3:4:3 ratio.

Can border/accent with Standard™, Napa™, Balsam™ and other 60 mm options for consistent grades.

PATTERNS

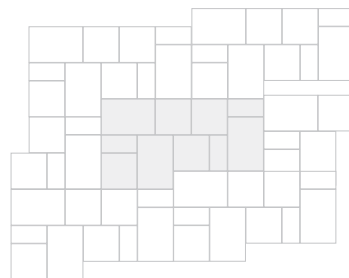
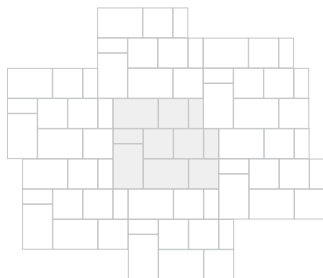

13" Soldier Course

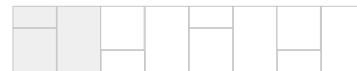

8.66" Soldier Course



STANDARD™



CLASSIC SERIES | 60 & 80 mm

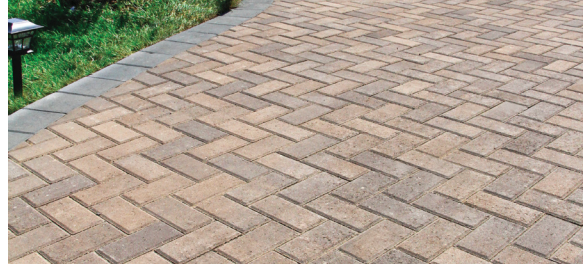

UNITS



3.93 x 7.87 x 2.36 in
100 x 200 x 60 mm
Units/bundle: 486
Units/layer: 54

3.93 x 7.87 x 3.15 in
100 x 200 x 80 mm
Units/bundle: 432
Units/layer: 54

BUNDLE OVERVIEW



COLOURS



Buff Mix*



Buff-Brown Mix*



Charcoal



Grey

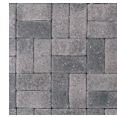

Grey Mix



Red*



Red Mix*



Salmon Mix*

BUNDLE SPECIFICATIONS

60mm	IMPERIAL	METRIC
Coverage	106 ft ²	9.85 m ²
Weight	2862 lbs	1298.18 kg
Rows	9	
Coverage per row	11.78 ft ²	1.09 m ²
Lineal coverage	156.2 / 312.8 ft	47.7 / 95.4 m
Lineal coverage per row	17.35 / 34.75 ft	5.3 / 10.6 m
Coverage per unit	0.22 ft ²	0.02 m ²
Units per ft ² / m ²	4.59	49.34

80mm	IMPERIAL	METRIC
Coverage	94.2 ft ²	8.72 m ²
Weight	3304 lbs	1499 kg
Rows	8	
Coverage per row	11.78 ft ²	1.09 m ²
Lineal coverage	138.8 / 278.0 ft	42.4 / 84.8 m
Lineal coverage per row	17.35 / 34.75 ft	5.3 m / 10.6 m
Coverage per unit	0.22 ft ²	0.02 m ²
Units per ft ² / m ²	4.59	49.34

PATTERNS

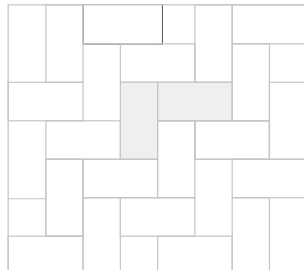
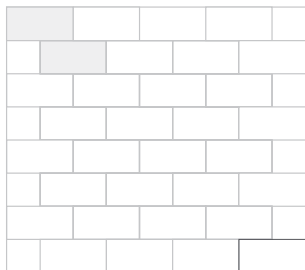

NOTES

For pedestrian and/or vehicular use.

Sold in full bundles only.

*80 mm are special order.

DOUBLE STANDARD™

CLASSIC SERIES | 60 mm



UNIT



7.87 x 7.87 x 2.36 in
 200 x 200 x 60 mm
 Units/bundle: 216
 Units/row: 24

BUNDLE OVERVIEW



COLOURS



Charcoal



Grey



Grey Mix



Red Mix



Salmon Mix

BUNDLE SPECIFICATIONS

	IMPERIAL	METRIC
Coverage	94 ft ²	8.73 m ²
Weight	2538 lbs	1151.2 kg
Rows	9	
Coverage per row	10.44 ft ²	0.97 m ²
Lineal coverage	144 ft	43.9 m
Lineal coverage per row	16 ft	4.88 m
Coverage per unit	0.44 ft ²	0.04 m ²
Units per ft ² / m ²	2.3	24.74

PATTERNS

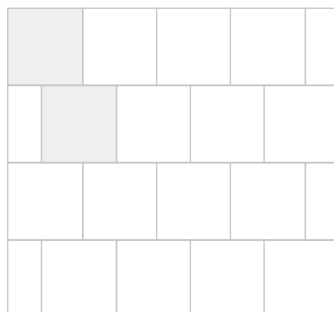
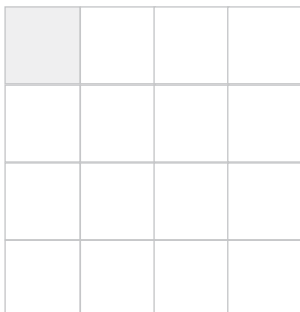

NOTES

For pedestrian and/or vehicular use. Provides a smooth square surface with subtle edges.

Sold in full bundles only.



WALLS



46	Soho™
47	Barnbeam™
48	Arlington™
49	Hazelton™
50	Garden Lock™
52	Parkwall®
54	Ridgewall®
56	Stacker
57	Ikon™
58	Rockton
59	Grand Ledge

PHYSICAL & GEOMETRICAL CHARACTERISTICS

Dry-cast Wall Units

Characteristics	ASTM C 1372 ²
Compressive strength	20.7 MPa (3000 psi) min.
Durability to freeze thaw cycles Mass loss	After 100 cycles (max): 1% After 150 cycles (max): 1.5%
Water absorption	208 kg/m ³ max. (13 lb/ft ³)
Dimension tolerance ¹	Length: ±3 (1/8") Width: ±3 (1/8") Height: ±3 (1/8")

1. The dimensional tolerance prior to the application of architectural finishes.

2. ASTM C1372 Standard specification for Dry-Cast, SRW units.



SIGNATURE SERIES | SINGLE-SIDED FINISH | COLOUR THROUGHOUT



UNITS

4 Pack



A
13.78w x 3.94h x 8.85d in
350w x 100h x 225d mm
Units/bundle: 9
Units/layer: 3



B
17.72w x 3.94h x 8.85d in
450w x 100h x 225d mm
Units/bundle: 9
Units/layer: 3



C
21.65w x 3.94h x 8.85d in
550w x 100h x 225d mm
Units/bundle: 9
Units/layer: 3



D
25.59w x 3.94h x 8.85d in
650w x 100h x 225d mm
Units/bundle: 9
Units/layer: 3



Corner Unit
13.78w x 3.94h x 8.85d in
350w x 100h x 225d mm
Units/bundle: 60
Units/layer: 20

BUNDLE OVERVIEW

Blocks

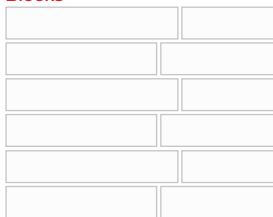

Corners

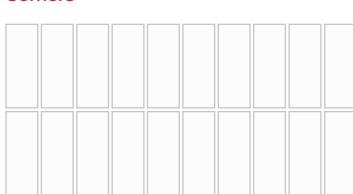

COLOURS

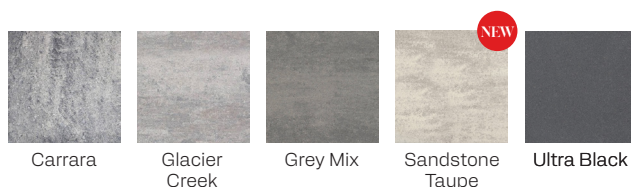

BUNDLE SPECIFICATIONS

Blocks	IMPERIAL	METRIC
Coverage	19.35 ft ²	1.8 m ²
Coverage per layer	6.45 ft ²	0.6 m ²
Lineal coverage	59.04 ft	18 m
Weight	1926 lbs	873.6 kg
Layers	3	-
Lineal coverage per layer	19.69 ft	6 m
Coverage per 4 pack	2.15 ft ²	0.2 m ²
Lineal coverage per 4 pack	6.56 ft	2 m
Weight per 4 pack	214 lbs	97 kg
4 packs per bundle	9	-
4 packs per layer	3	-

Corners	IMPERIAL	METRIC
Coverage	22.5 / 14.4 ft ²	2.1 / 1.35 m ²
Lineal coverage	44.4 / 69 ft	13.5 / 21 m
Weight	2196 lbs	996 kg
Coverage per unit	0.24 / 0.38 ft ²	0.02 / 0.04 m ²
Lineal coverage per unit	0.74 / 1.15 ft	0.225 / 0.35 m
Weight per unit	36.6 lbs	16.6 kg

NOTES

Made with DesignLoc® surface refinement technology.

Soho™ can be installed without a coping as the colour is throughout the units.

Use Arlington™ or Garden Lock™ coping for an added finished touch.

Soho™ corner creates a 22.5" x 22.5" column. Sold and packaged separately from the block units.

BARNBEAM™ WALL + CURB

SIGNATURE SERIES | WETCAST DOUBLE-SIDED WALL | DRY STACK



UNIT



40w x 6h x 8d in
1015w x 152h x 203d mm
Units/bundle: 16

BUNDLE OVERVIEW



COLOUR



Weatherwood

BUNDLE SPECIFICATIONS

	IMPERIAL	METRIC
Coverage	26.6 ft ²	2.47 m ²
Lineal Coverage	53.3 ft	16.24 m
Weight	2527 lbs	1146 kg
Weight per unit	158 lbs	71.7 kg
Coverage per unit	1.66 ft ²	0.15 m ²
Lineal coverage per unit	3.33 ft	1.01 m

1/2 OFF-SET

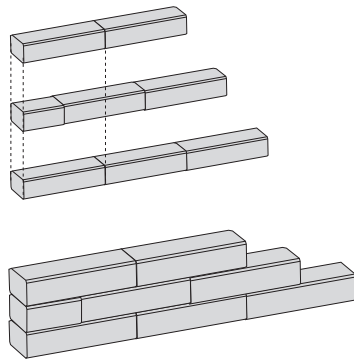

Create 1/2 unit (20" w) to start alternating rows.

TYPICAL CROSS SECTION

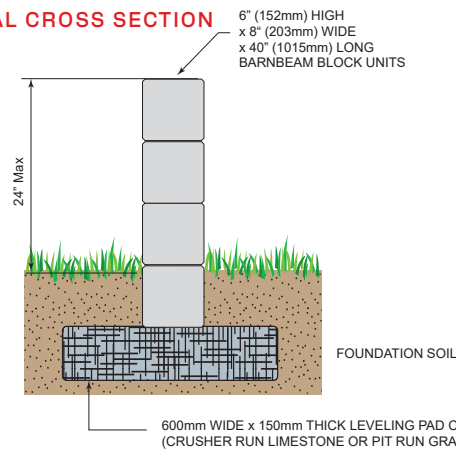

CORNER CONSTRUCTION

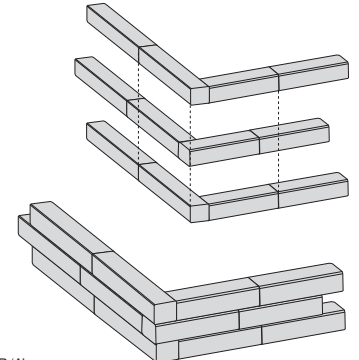

Alternate overlap each row.

NOTES

The Barnbeam™ wall combines the natural grains and details of wood with the durability of concrete. These three sided units are produced using Best Way Stone's wet cast technology allowing for maximum detail and integral colouring throughout the surface.

Fire pit kit available

ARLINGTON™

CLASSIC SERIES | DOUBLE-SIDED SMOOTH WALL



UNITS



BLOCK

15.75w x 4.92h x 8.85d in
400w x 125h x 225d mm

CORNER / CURB

15.75w x 4.92h x 8.85d in
400w x 125h x 225d mm

COPING

15.75w x 2.36h x 10.23d in
400w x 60h x 260d mm

BUNDLE OVERVIEW

Block & Corner



Coping

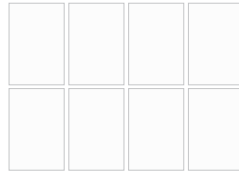

COLOURS

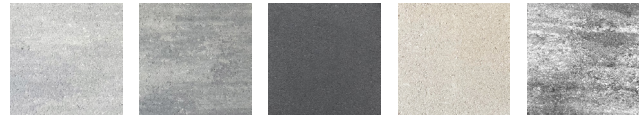

Colorado Grey

Grey Mix

Nightfall

Summer Mist

Winterborn

BUNDLE SPECIFICATIONS

Blocks

	IMPERIAL	METRIC
Coverage	26.9 ft ²	2.5 m ²
Lineal coverage	65.6 ft	20 m
Weight	2600 lbs	1179.3 kg
Units	50	-
Coverage per unit	0.53 ft ²	0.05 m ²
Lineal coverage per unit	1.31 ft	0.4 m

Corner / Curb

	IMPERIAL	METRIC
Coverage	26.9 / 15 ft ²	2.5 / 1.39 m ²
Lineal coverage	37 / 65.6 ft	11.25 / 20 m
Weight	2595 lbs	1177 kg
Units	50	-
Coverage per unit	0.3 / 0.53 ft ²	0.027 / 0.05 m ²
Lineal coverage per unit	0.74 / 1.31 ft	0.225 / 0.4 m

Coping

	IMPERIAL	METRIC
Lineal Coverage	94.5 ft	28.8 m
Weight	2146 lbs	973.4 kg
Units	72	-
Lineal coverage per unit	1.31 ft	0.4 m
Sections	4	-
Lineal coverage per section	23.6 ft	7.2 m

TYPICAL CROSS SECTION

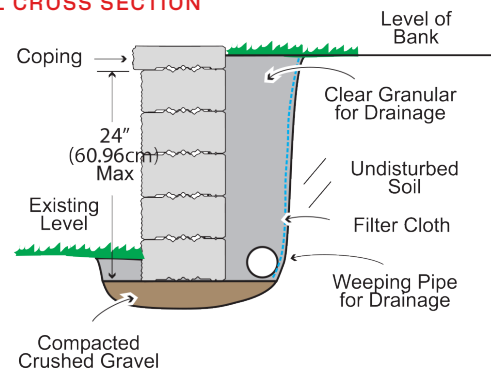

*Set-back can be erected to 36" matching Garden Lock™.

NOTES

Smooth double-sided wall unit with a locking feature that works in tandem with Garden Lock™ and Hazelton™.

HAZELTON™

CLASSIC SERIES | DOUBLE-SIDED TEXTURED WALL



UNITS



BLOCK

11.81w x 4.92h x 8.85d in
300w x 125h x 225d mm
Units/bundle: 60

CORNER

12.8w x 4.92h x 6.9d in
325w x 125h x 175d mm
Units/bundle: 48

BUNDLE OVERVIEW

Block

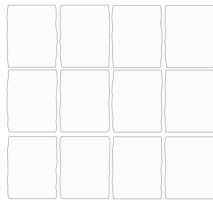

Corner



COLOURS



Beige Mix

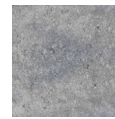

Grey Mix

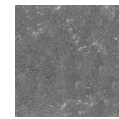

Ultra Black

BUNDLE SPECIFICATIONS

Blocks

	IMPERIAL	METRIC
Coverage	24.21 ft ²	2.25 m ²
Lineal coverage	59.05 ft	18 m
Weight	2296 lbs	1041.5 kg
Weight per unit	38.3 lbs	17.4 kg
Coverage per unit	0.404 ft ²	0.038 m ²
Lineal coverage per unit	0.984 ft	0.3 m

Corner

	IMPERIAL	METRIC
Coverage	11.3 / 21 ft ²	1.05 / 1.95 m ²
Lineal coverage	27.6 / 51.2 ft	8.4 / 15.6 m
Weight	1642 lbs	744 kg
Weight per unit	34.2 lbs	15.5 kg
Coverage per unit	0.23 / 0.44 ft ²	0.02 / 0.04 m ²
Lineal coverage per unit	0.57 / 1.06 ft	0.17 / 0.32 m

NOTES

A double-sided textured wall with a locking system that allows for vertical or set-back designs.

The corner creates a 20" x 20" column.

Block and corner units are sold separately. Arlington™, Montana™, or Garden Lock™ coping are ideal to complete Hazelton™ wall.

Maximum height with set-back: 36"
Maximum height without set-back: 24"

TYPICAL CROSS SECTIONS

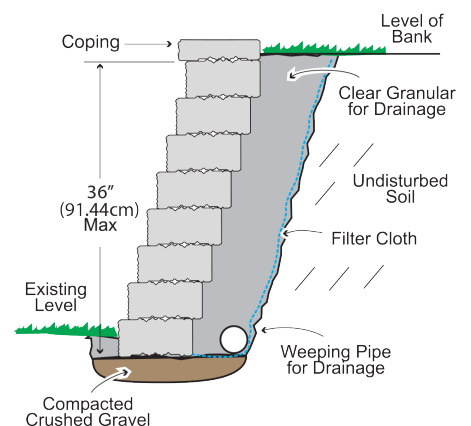
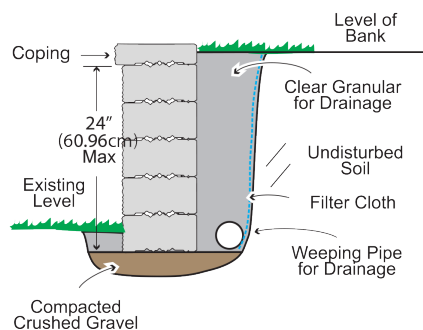

GARDEN LOCK™

CLASSIC SERIES | DOUBLE-SIDED WALL | SPLIT-FACE

TRIPLE UNITS



LARGE

14.96w x 4.92h x 8.85d in
380w x 125h x 225d mm
Units: 25



MEDIUM

9.84w x 4.92h x 8.85d in
250w x 125h x 225d mm
Units: 25



SMALL

7.48w x 4.92h x 8.85d in
190w x 125h x 225d mm
Units: 25

BUNDLE OVERVIEW



COLOURS



Beige Mix

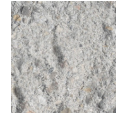

Grey



Grey Mix



Winterborn

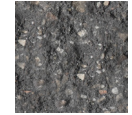

Ultra Black
(Straight Coping
Only)

BUNDLE SPECIFICATIONS

Blocks	IMPERIAL	METRIC
Coverage	27.5 ft ²	2.55 m ²
Lineal coverage	67.26 ft	20.5 m
Weight	3113 lbs	1412.16 kg
Weight per triple	124.5 lbs	56.5 kg
Coverage per triple	1.1 ft ²	0.1 m ²
Lineal coverage per triple	2.69 ft	0.82 m
Sections	5	-
Coverage per section	5.5 ft ²	0.51 m ²
Lineal coverage per section	13.45 ft	4.1 m

NOTES

A double-sided split face wall that can be installed vertically or set-back. Specific medium blocks can be installed on their side, identified with locking feature along the vertical side of block unit.

Triple units are sold and packaged together in a 1:1:1 ratio. Use Arlington™ or Garden Lock™ coping for best finish.

Maximum height with set-back: 36" | Maximum height without set-back: 24"

20 wedge blocks and 20 wedge coping units make a circle with 53.5" outside diameter and 33" inside diameter.

TYPICAL CROSS SECTIONS

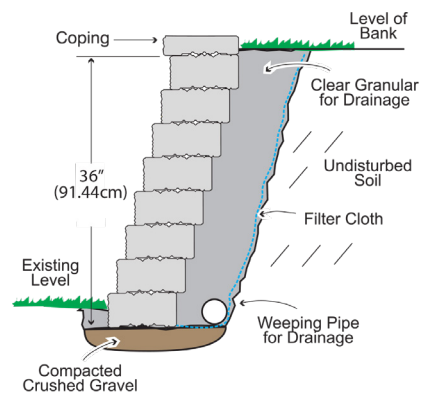
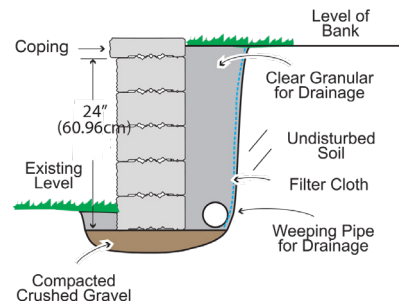



UNITS

BUNDLE SPECIFICATIONS



STRAIGHT COPING

15.74w x 2.95h x 10.23d in
400w x 75h x 260d mm

	IMPERIAL	METRIC
Lineal coverage	84 ft	25.6 m
Weight	2458 lbs	1114.75 kg
Units	64	-
Lineal coverage per unit	1.31 ft	0.4 m
Sections	4	-
Lineal coverage per section	21 ft	6.4 m



CORNER

13.46w x 4.92h x 8.85d in
342w x 125h x 225d mm

	IMPERIAL	METRIC
Coverage	11.8 / 18.3 ft ²	1.1 / 1.7 m ²
Weight	1786 lbs	810 kg
Units	40	
Coverage per unit	0.3 / 0.4 ft ²	0.03 / 0.04 m ²
Lineal coverage	29.5 / 44.9 ft	9 / 13.68 m
Lineal coverage per unit	0.74 / 1.12 ft	0.23 / 0.34 m

Corner creates a 22.3" x 22.3" column base



WEDGE BLOCK

8.07(5.31)w x 4.92h x 8.85d in
205(135)w x 125d x 225d mm

	IMPERIAL	METRIC
Coverage	23 / 34.7 ft ²	2.14 / 3.22 m ²
Weight	3013 lbs	1366.45 kg
Layers	125	-
Coverage per unit	0.21 / 0.32 ft ²	0.02 / 0.03 m ²
Lineal coverage	55.38 / 84.06 ft	16.88 / 25.63 m
Lineal coverage per unit	0.46 / 0.66 ft	0.2 / 0.14 m



WEDGE COPING

8.23(5.17)w x 2.95h x 10.23d in
209(131)w x 75h x 260d mm

	IMPERIAL	METRIC
Weight	2635 lbs	1195.31 kg
Units	160	-
Lineal coverage	55.25 / 87.89 ft	16.82 / 26.76 m
Lineal coverage per unit	0.35 / 0.55 ft	0.11 / 0.17 m

PARKWALL®

CLASSIC SERIES / SPLIT-FACE WALL / DOUBLE-SIDED OPTION / SINGLE SIDE SMOOTH OPTION

UNITS



REGULAR BLOCK

7.87w x 5.9h x 11.61d in
200w x 150h x 295d mm

TAPERED BLOCK

7.87w (6.89w) x 5.9h x 11.61d in
200w (175w) x 150h x 295d mm

BUNDLE SPECIFICATIONS

	IMPERIAL	METRIC
Coverage	20 ft ²	1.85 m ²
Lineal coverage	40 ft	12 m
Weight	2575 lbs	1167.95 kg
Units	60	-
Coverage per unit	0.34 ft ²	0.03 m ²
Lineal coverage per unit	0.67 ft	0.2 m



CORNER

7.87w x 5.9h x 11.61d in
200w x 150h x 295d mm

	IMPERIAL	METRIC
Coverage	-	-
Lineal coverage	15.75 / 23.23 ft	4.8 / 7.08 m
Weight	1064 lbs	482.6 kg
Units	24	-
Coverage per unit	-	-
Lineal coverage per unit	0.66 / 0.97 ft	0.2 / 0.3 m

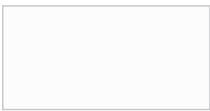

COPING

23.62w x 2.95h x 11.81d in
600w x 75h x 300d mm

	IMPERIAL	METRIC
Coverage	64 ft	19.2 m
Weight	2144 lbs	972 kg
Units	32	-
Lineal coverage per unit	2 ft	0.6 m
Sections	4	-
Lineal coverage per section	16 ft	4.8 m

NOTES

A single-sided split face wall, with a double-sided option. Regular and tapered blocks can be split along back joint to remove smooth face and create double-sided finish.

Can be installed vertically or set-back, front-facing or reversed, or any combination.

Alternate a full 4 corner column row of the same indicated corners (Rights / Lefts) to make a 19.5" x 19.5" column base.

Maximum height with set-back: 48"
Maximum height without set-back: 30"

EXAMPLE CROSS SECTIONS

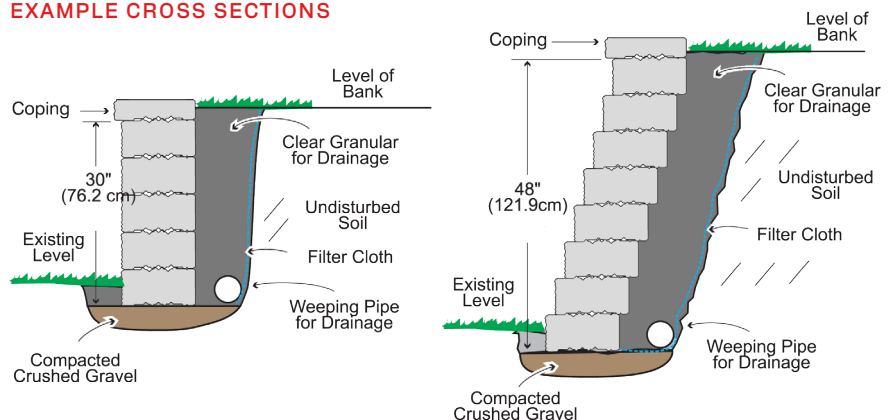



BUNDLE OVERVIEW

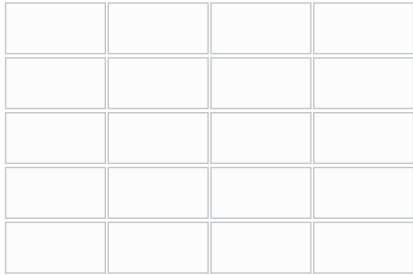

Regular & Tapered Block



Corners



Coping

COLOURS



Beige Mix

Grey

Grey Mix

Winterborn

Ultra Black
(Coping Only)

DESIGN VERSATILITY

Split-Face Vertical



Smooth-Face Accent



In / Out-Set Accent



Smooth-Face In / Out-Set



Combination Accenting

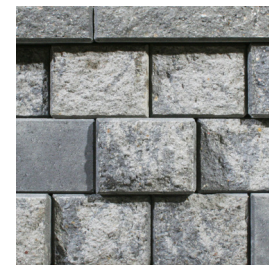

No block manipulation required. Simply turn the block, or set in and out as desired along the patented locking feature.

RIDGEWALL®

CLASSIC SERIES | LARGE SEGMENTAL RETAINING WALL SYSTEM

UNITS

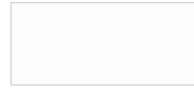
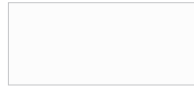
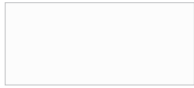

435 Split Block
/ **435 Smooth Block**
39.4w x 7.68h x 17.1d in
1000w x 195h x 435d mm

90° Corner
36.9w x 7.68h x 17.1d in
937.5w x 195h x 435d mm

45° Corner
39.4w x 7.68h x 17.1d in
1000w x 195h x 435d mm

Copping
39.4w x 7.68h x 19.7d in
1000w x 195h x 500d mm

870 Double
39.4w x 7.68h x 34.25d in
1000w x 195h x 870d mm

BUNDLE SPECIFICATIONS

435 Split / Smooth

	IMPERIAL	METRIC
Coverage	12.61 ft ²	1.2 m ²
Lineal coverage	19.68 ft	6 m
Weight	2370 lbs	1075.2 kg
Units	6	-
Coverage per unit	2.1 ft ²	0.2 m ²
Lineal coverage per unit	3.28 ft	1 m

Copping

	IMPERIAL	METRIC
Coverage	12.61 ft ²	1.2 m ²
Lineal coverage	19.68 ft	6 m
Weight	2982 lbs	1352.4 kg
Units	6	-
Coverage per unit	2.1 ft ²	0.2 m ²
Lineal coverage per unit	3.28 ft	1 m

90° Corner

	IMPERIAL	METRIC
Coverage	17.22 ft ²	1.62 m ²
Lineal coverage	26.97 ft	8.24 m
Weight	2340 lbs	1061.4 kg
Units	6	-
Coverage per unit	2.87 ft ²	0.27 m ²
Lineal coverage per unit	4.49 ft	1.37 m

45° Corner

	IMPERIAL	METRIC
Coverage	13.5 ft ²	1.26 m ²
Lineal coverage	21.45 ft	6.56 m
Weight	2226 lbs	1009.8 kg
Units	6	-
Coverage per unit	2.25 ft ²	0.21 m ²
Lineal coverage per unit	3.57 ft	1.09 m

870 Double

	IMPERIAL	METRIC
Coverage	6.30 ft ²	0.600 m ²
Lineal coverage	9.85 ft	3 m
Weight	2370 lbs	1075.2 kg
Units	3	-
Coverage per unit	2.10 ft ²	0.4 m ²
Lineal coverage per unit	3.28 ft	1 m

RIDGE & KEY SYSTEM

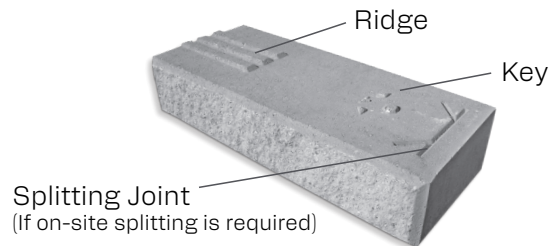

NOTES

When installing the RidgeWall®, install units ridge-to-ridge and key-to-key where possible. Can be installed vertically or with 50mm set-back. **Engineering services available, email sales@bestwaystone.com for more details.**



**BUNDLE OVERVIEW
(ALL UNITS)**



TYPICAL CROSS SECTION

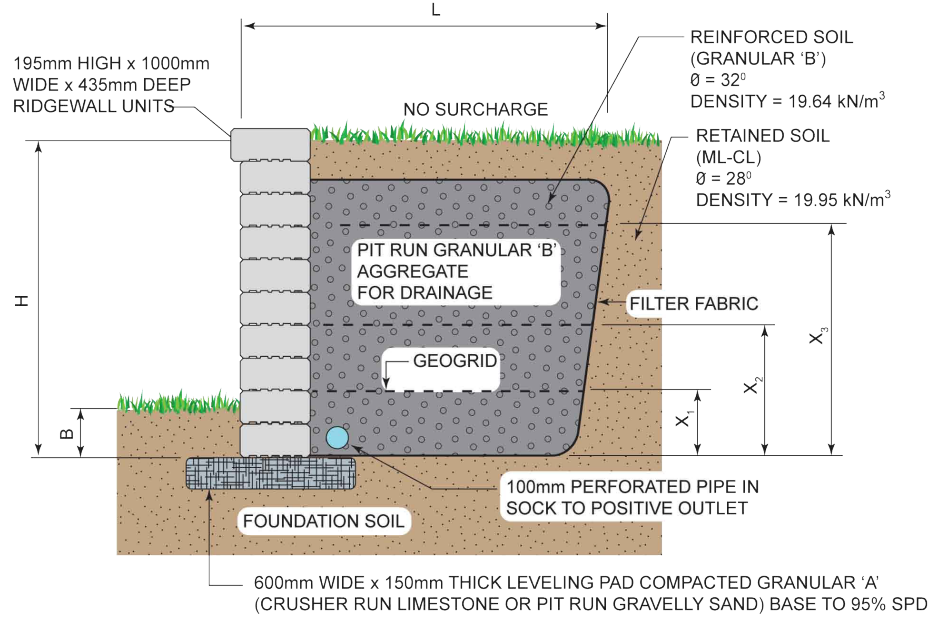

GEOGRID REINFORCED RIDGEWALL
CROSS SECTION WITH LEVEL BACKFILL
AND NO SURCHARGE

COLOURS



Ridge-to-Ridge & Key-to-Key Installation (Best Practice where possible)

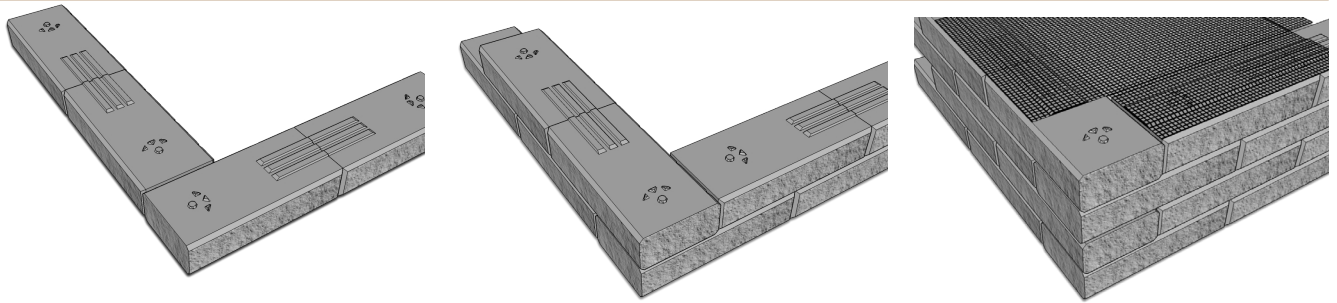

90 Corner - Row 1 & 2 (Continue same sequence for following rows) + typical grid placement

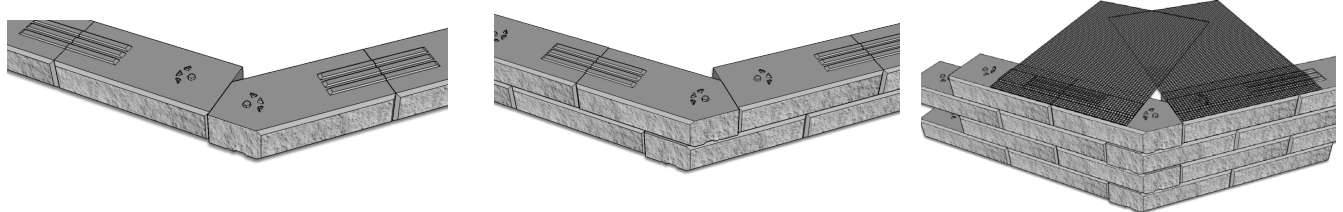

45 Corner - Row 1 & 2 (Continue same sequence for following rows) + typical grid placement

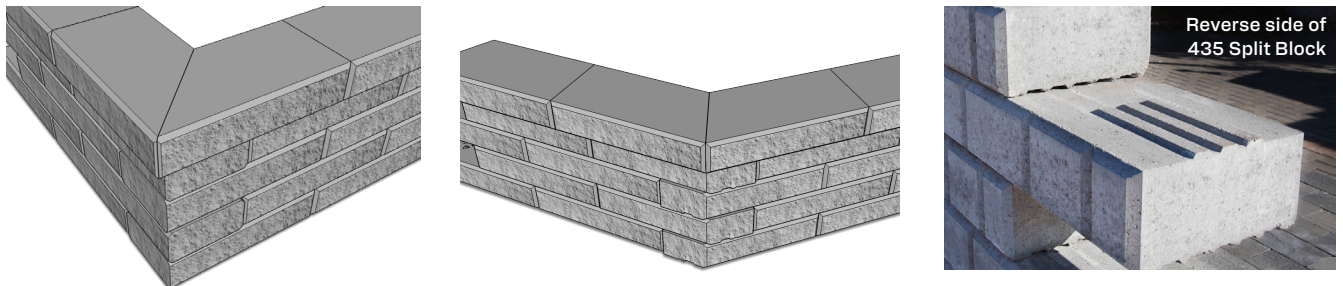

STACKER

CLASSIC SERIES | CLASSIC SMOOTH & TUMBLED FINISH WALL



UNITS



ANTICO®

11.81w x 3.92h x 7.87d in
300w x 100h x 200d mm
Units/bundle: 96

CLASSIC SMOOTH

11.81w x 3.92h x 7.87d in
300w x 100h x 200d mm
Units/bundle: 90

BUNDLE OVERVIEW

Antico®

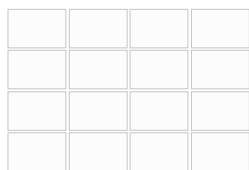

Classic Smooth



ANTICO COLOURS



Beige Mix

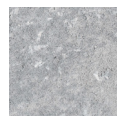

Grey Mix

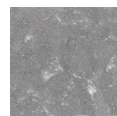

Ultra Black

CLASSIC SMOOTH COLOURS



Beige Mix



Grey Mix

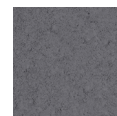

Ultra Black

BUNDLE SPECIFICATIONS

Antico®

	IMPERIAL	METRIC
Coverage	20.67 / 31 ft ²	1.92 / 2.88 m ²
Lineal coverage	63 / 94.5 ft	19.2 / 28.8 m
Weight	2861 lbs	1297.6 kg
Weight per unit	29.8 lbs	13.5 kg
Coverage per unit	0.21 / 0.32 ft ²	0.02 / 0.03 m ²
Lineal coverage per unit	0.66 / 0.98 ft	0.2 / 0.3 m
Sections	4	-
Coverage per section	5.17 / 7.75 ft ²	0.48 / 0.72 m ²
Lineal coverage per section	15.75 / 23.62 ft	4.8 / 7.2 m

Classic Smooth

	IMPERIAL	METRIC
Coverage	19.28 / 28.93 ft ²	1.8 / 2.7 m ²
Lineal coverage	59.02 / 88.58 ft	18 / 27 m
Weight	2682 lbs	1216.5 kg
Weight per unit	29.8 lbs	13.5 kg
Coverage per unit	0.21 / 0.32 ft ²	0.02 / 0.03 m ²
Lineal coverage per unit	0.66 / 0.98 ft	0.2 / 0.3 m
Layers	3	-
Coverage per layer	6.43 / 9.64 ft ²	0.6 / 0.9 m ²
Lineal coverage per layer	19.67 / 29.53 ft	6 / 9 m

NOTES

Stacker is a versatile stacking block that can be applied to multiple applications such as garden walls, outdoor kitchens, columns, water and fire features.

Creates a 19.5" x 19.5" column base.

Antico® and Smooth Stacker sold and packaged separately.

IKON™

CLASSIC SERIES | SMOOTH FINISH WALL | LARGE SRW



UNITS



BLOCK

39.4w x 6.7h x 14d in
1000w x 170h x 355d mm
Units/bundle: 9

COPING

39.4w x 6.7h x 14d in
1000w x 170h x 355d mm
Units/bundle: 9

BUNDLE OVERVIEW



COLOURS

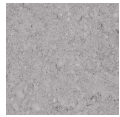

Grey

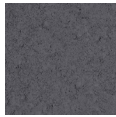

Ultra Black

OFF-SET LOCKING SYSTEM

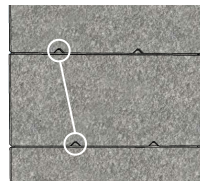

VERTICAL



Alternate the direction of units each row. Off-set locking feature align to create vertical finish.

30 MM OFF-SET

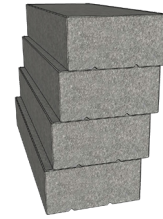

Install units in the same direction. Off-set locking feature creates a 30 mm set back.

BUNDLE SPECIFICATIONS

	IMPERIAL	METRIC
Coverage	16.5 ft ²	1.53 m ²
Lineal coverage	29.53 ft	9 m
Weight	2745 lbs	1245 kg
Weight per unit	305 lbs	138.3 kg
Coverage per unit	1.83 ft ²	0.17 m ²
Lineal coverage per unit	3.28 ft	1 m

TYPICAL CROSS SECTION

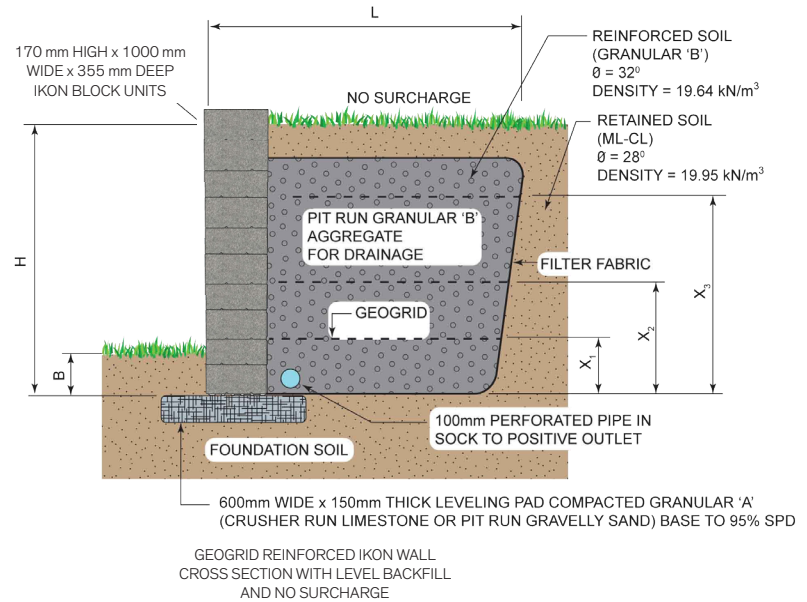

NOTES

Large format segmental retaining wall with a double-sided smooth finish. Units can be reversed to set-back the wall system.

Engineering details and services available for the Ikon™ wall system, email sales@bestwaystone.com for details.

ROCKTON

ROSETTA SERIES | DOUBLE-SIDED | EMBOSSED NATURAL FINISH WALL



UNITS (6 PACK)



A	B	C	D	Corner Unit
42w x 6h x 10.5d in	30w x 6h x 10.5d in	21w x 6h x 10.5d in	12w x 6h x 10.5d x in	21w x 6h x 10.5d in
1067w x 152h x 267d mm	762w x 152h x 267d mm	533w x 152h x 267d mm	305w x 152h x 267d mm	533w x 152h x 267d mm
Units/bundle: 6	Units/bundle: 3	Units/bundle: 6	Units/bundle: 3	Units/bundle: 24
Units/layer: 2	Units/layer: 1	Units/layer: 2	Units/layer: 1	

BUNDLE OVERVIEW

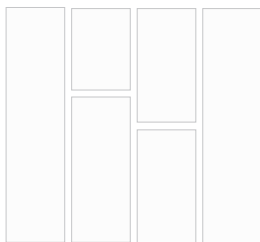

COLOURS

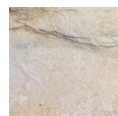

Fond Du Lac

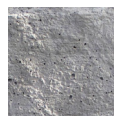

Manitou
Blend

BUNDLE SPECIFICATIONS

Block	IMPERIAL	METRIC
Coverage	21 ft ²	1.95 m ²
Lineal coverage	42 ft	12.8 m
Weight	2500 lbs	1134 kg
Layers (6 packs)	3	-
Coverage per layer (6 pack)	7 ft ²	0.65 m ²
Lineal coverage per layer (6 pack)	14 ft	4.26 m
Weight per layer (6 pack)	833 lbs	378 kg

Corner	IMPERIAL	METRIC
Coverage	31.5 ft ²	2.9 m ²
Lineal coverage	63 ft	19.2 m
Weight	2500 lbs	1134 kg
Coverage per unit	1.31 ft ²	0.12 m ²
Lineal coverage per unit	2.6 ft	0.79 m
Weight per unit	104 lbs	47.25 kg

NOTES

Rockton provides a large format natural finish. Corner units create a 22.5"x22.5" column. Block units sold and packaged together. Each bundle layer represents a 6 pack.

Corner units packaged and sold separately.

GRAND LEDGE

ROSETTA SERIES | ENGINEERED WALL SYSTEM



UNITS



Block A

72w x 12h x 20d in
1829w x 305h x 508d mm
Units/bundle: 1



Block B

60w x 12h x 20d in
1524w x 305h x 508d mm
Units/bundle: 1



Block C

48w x 12h x 20d in
1219w x 305h x 508d mm
Units/bundle: 1



Block D

36w x 12h x 20d in
914w x 305h x 508d mm
Units/bundle: 1

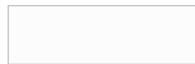

Corner A

50.5w x 12h x 25.5d in
1283w x 305h x 648d mm
Units/bundle: 1

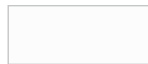

Corner B

46w x 12h x 21d in
1168w x 305h x 533d mm
Units/bundle: 1



Corner C

42.75w x 12h x 19.75d in
1086w x 305h x 502d mm
Units/bundle: 1

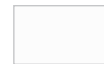

Corner D

35.25w x 12h x 24.25d in
895w x 305h x 641d mm
Units/bundle: 1

BUNDLE SPECIFICATIONS

Block	IMPERIAL	METRIC
Coverage	18 ft ²	1.67 m ²
Lineal coverage	18 ft	5.5 m
Weight	4202 lbs	1906 kg

Corner	IMPERIAL	METRIC
Coverage	14 ft ²	1.30 m ²
Lineal coverage	14.54 ft	4.43 m
Weight	3796 lbs	1722 kg

COLOURS

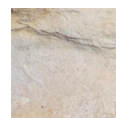

Fond Du Lac

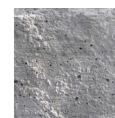

Manitou Blend

NOTES

Made durable with the finest granite aggregate & 24 unique wall textures.

Sold in full bundles only.

Block & corner units are sold and packaged separately.



STEPS,
CAPS
& CURBS



62	Camden™ Step
63	Ikon™ Step
63	Ridge Step™
64	Sopra™ Coping
64	Montana™ Cap
64	Montana™ Column Cap
65	Barollo® 10" Round Edge
65	Barollo® 8" Round Edge
65	28 x 28 Smooth™ Cap
65	Parkwall® Column Cap
66	Arlington™ Curb
66	Antico® Curb
66	Garden Curb™
66	Driveway Curb™

STEPS

UNITS

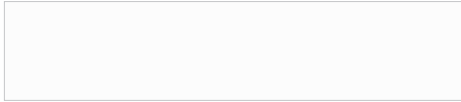

72" CAMDEN™ STEP

72w x 6h x 16d in
1830w x 152h x 406d mm



48" CAMDEN™ STEP

48w x 6h x 16d in
1219w x 152h x 406d mm



14" CAMDEN™ FILLER / CURB*

14w x 7d x 6h in
356w x 178d x 152h mm



28" CAMDEN™ FILLER / CURB*

28w x 7d x 6h in
711w x 178d x 152h mm

BUNDLE SPECIFICATIONS

	IMPERIAL	METRIC
Weight	2144 lbs	972 kg
Units	4	-
Lineal coverage	24 ft	7.31 m
Lineal coverage per unit	6 ft	1.83 m

COLOURS



Ebony



Granite Grey

	IMPERIAL	METRIC
Weight	1324 lbs	600.73 kg
Units	6	-
Lineal coverage	24 ft	7.32 m
Lineal coverage per unit	4 ft	1.22 m

COLOURS



Ebony



Granite Grey

	IMPERIAL	METRIC
Weight	2232 lbs	1008 kg
Units	48	-
Lineal coverage	-	-
Lineal coverage per unit	-	-

COLOURS

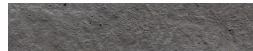

Ebony



Granite Grey

	IMPERIAL	METRIC
Weight	2232 lbs	1008 kg
Units	24	-
Lineal coverage	-	-
Lineal coverage per unit	-	-

COLOURS



Ebony



Granite Grey

*Turn the fillers on their side, with most textured side facing up to make a decorative curb.



STEP & FILLER CROSS SECTION

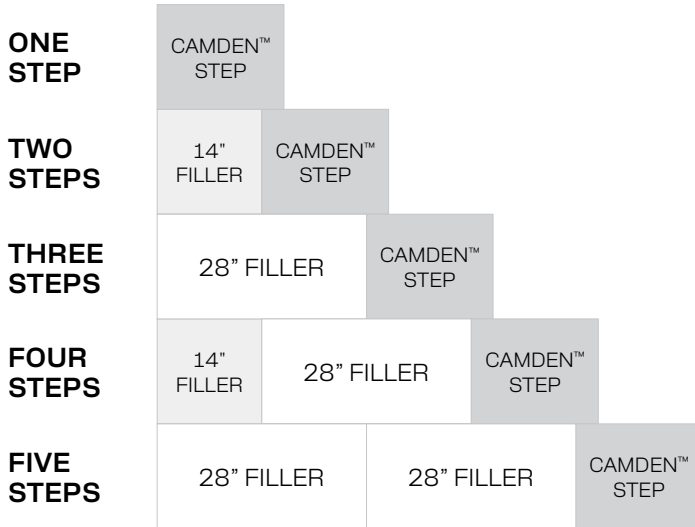

For every step that you need to make, you will need to double the quantity of fillers for each side. (i.e. for three steps, you would need two 14" fillers, two 28" fillers, and three Camden Steps)

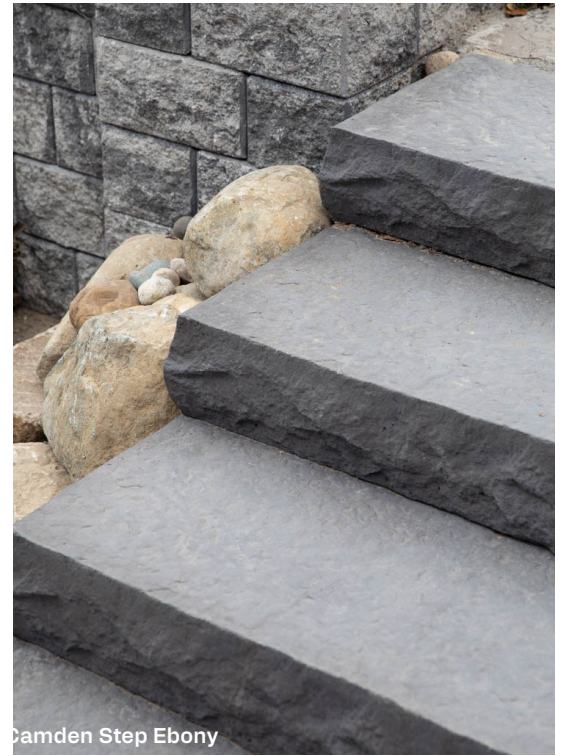

UNITS

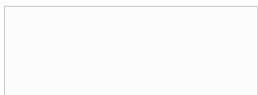

IKON™ STEP

39.4w x 6.7h x 14d in
1000w x 170h x 355d mm



BUNDLE SPECIFICATIONS

	IMPERIAL	METRIC
Weight	2745 lbs	1245 kg
Units	9	-
Lineal coverage	29.5 ft	9 m
Lineal coverage per unit	3.28 ft	1 m

COLOURS



Grey



Ultra Black

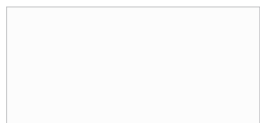

RIDGE STEP™

39.4w x 7.68h x 19.7d in
1000w x 195h x 500d mm



	IMPERIAL	METRIC
Weight	2982 lbs	1352.4 kg
Units	6	-
Lineal coverage	19.68 ft	6 m
Lineal coverage per unit	3.28 ft	1 m

COLOURS

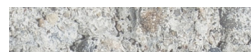

Grey



Grey Mix

CAPS

UNITS

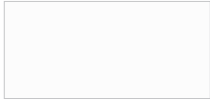

SOPRA™ COPING
 28w x 14d x 2.36h in
 710w x 355d x 60h mm

BUNDLE SPECIFICATIONS



	IMPERIAL	METRIC
Weight	2079 lbs	943 kg
Units	27	-
Lineal coverage	62.9 ft	19.2 m
Lineal coverage per unit	2.3 ft	0.7 m

COLOURS



Grey



Ultra Black

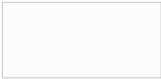

MONTANA™ CAP
 21.3w x 10.6d x 2h in
 540w x 270d x 50h mm



	IMPERIAL	METRIC
Weight	825 lbs	374 kg
Units	22	-
Lineal coverage	38.9 ft	11.9 m
Lineal coverage per unit	1.77 ft	0.54 m

COLOURS



Ebony



Granite

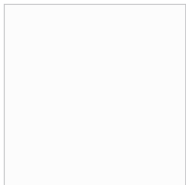

MONTANA™ COLUMN CAP
 23.62w x 23.62d x 2.95h in
 600w x 600d x 75h mm



	IMPERIAL	METRIC
Weight	1096 lbs	496 kg
Units	8	-

COLOURS



Ebony



Granite



UNITS



BAROLLO® 10" ROUND EDGE

9.84w x 12.46d x 2.95h in
250w x 317d x 75h mm

BUNDLE SPECIFICATIONS



	IMPERIAL	METRIC
Weight	2136 lbs	968.86 kg
Units	81	-
Lineal coverage	66.42 ft	20.25 m
Lineal coverage per unit	0.82 ft	0.25 m

COLOURS



Grey



Ultra Black



BAROLLO® 8" ROUND EDGE

7.87w x 12.46d x 2.95h in
200w x 317d x 75h mm



	IMPERIAL	METRIC
Weight	1980 lbs	898 kg
Units	90	-
Lineal coverage	59.04 ft	17.95 m
Lineal coverage per unit	0.65 ft	0.20 m

COLOURS



Colorado Grey



Nightfall



Summer Mist



28 x 28 SMOOTH™ CAP

27.95w x 27.95w x 3.15h in
710w x 710d x 80h mm



	IMPERIAL	METRIC
Weight	1504 lbs	684 kg
Units	8	-

COLOURS



Ebony



Granite Grey

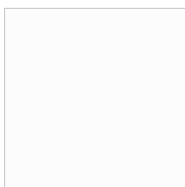

PARKWALL® COLUMN CAP

23.62w x 23.62d x 2.95h in
600w x 600d x 75h mm



	IMPERIAL	METRIC
Weight	2280 lbs	1034 kg
Units	16	-

COLOURS

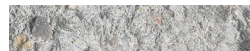

Grey



Ultra Black



CURBS

UNITS



ARLINGTON™ CURB

15.75w x 4.92h x 8.85d in
400w x 125h x 225d mm



BUNDLE SPECIFICATIONS

	IMPERIAL	METRIC
Weight	2595 lbs	1177 kg
Units	50	-
Lineal coverage	65.6 ft	20 m
Lineal coverage per unit	1.31 ft	0.4 m

COLOURS



ANTICO® CURB

15.75w x 5.91h x 3.94d in
400w x 150h x 100d mm



	IMPERIAL	METRIC
Weight	1841 lbs	835.79 kg
Units	64	-
Lineal coverage	84 ft	25.6 m
Lineal coverage per unit	1.31 ft	0.4 m

COLOURS

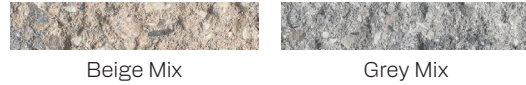

GARDEN CURB™

31.5w x 5.91h x 3.94d in
800w x 150h x 100d mm



	IMPERIAL	METRIC
Weight	2355 lbs	1068.12 kg
Units	40	-
Lineal coverage	105 ft	32 m
Lineal coverage per unit	2.63 ft	0.8 m

COLOURS

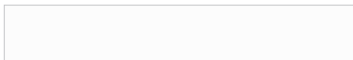
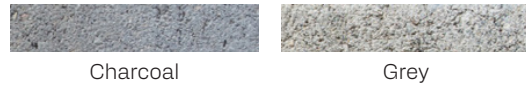

DRIVEWAY CURB™

39.4w x 5.9h x 5.9d in
1000w x 150h x 150d mm



	IMPERIAL	METRIC
Weight	2193 lbs	994.55 kg
Units	20	-
Lineal coverage	65.6 ft	20 m
Lineal coverage per unit	3.28 ft	1 m

COLOURS

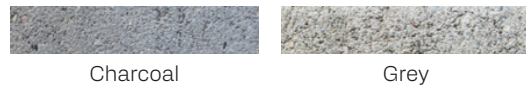





ENVIRO



		mm
70	Solar Reflective Rooftop Paver	50
71	EcoFlow® Permeable Paver	80

PHYSICAL & GEOMETRICAL CHARACTERISTICS

Precast Concrete Paving Slabs

Characteristics	CSA A231.1
Flexural Strength	5.0 MPa (725 psi) min.
Freeze-thaw durability with use of deicing salt	Mass loss (max): 225 g/m ² at 28 cycles Mass loss (max): 500 g/m ² at 49 cycles
Dimensional tolerance ¹	Length and Width: -1.0 mm to +2.0 mm Thickness: +/-3 mm
Concave or Convex Warpage (Up to and including 450 mm)	+2.0 mm
Concave or Convex Warpage (Over 450 mm)	+3.0 mm

1. The dimensional tolerance prior to the application of architectural finishes.

Refer to page 29 for Paver characteristics.

SOLAR REFLECTIVE ROOFTOP PAVER

PREMIERE SERIES | 50mm (45 & 60mm)



UNIT

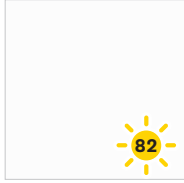

23.62 x 23.62 x 2 in
600 x 600 x 50 mm
Units/bundle: 20

BUNDLE OVERVIEW



COLOUR



PEDESTALS AVAILABLE (SPECIAL ORDER)



BUNDLE SPECIFICATIONS

50mm	IMPERIAL	METRIC
Coverage	77.49 ft ²	7.2 m ²
Weight	1840 lbs	834.6 kg
Units	20	-
Coverage per unit	3.87 ft ²	0.36 m ²
Lineal coverage	39.4 ft	12 m
Lineal coverage per unit	1.97 ft	0.6 m

45mm	IMPERIAL	METRIC
Coverage	92.99 ft ²	8.64 m ²
Weight	2148 lbs	974.4 kg
Units	24	-
Coverage per unit	3.87 ft ²	0.36 m ²
Lineal coverage	47.24 ft	14.4 m
Lineal coverage per unit	1.97 ft	0.6 m

60mm	IMPERIAL	METRIC
Coverage	69.74 ft ²	6.48 m ²
Weight	1956 lbs	887.2 kg
Units	18	
Coverage per unit	3.87 ft ²	0.36 m ²
Lineal coverage	35.46 ft	10.8 m
Lineal coverage per unit	1.97 ft	0.6 m

NOTES

For pedestrian and rooftop terracing use only. Provides a smooth white surface for maximum reflectivity. Meets SRI LEED® requirements for low slope roofing of 82+. Special order item, minimum quantities and lead time required.

When installing slabs on a pedestal set, ensure to consider load requirements. Refer to a project engineer for specific considerations.

Special order available for 45mm & 60mm.

ECOFLOW® PERMEABLE PAVER

SIGNATURE SERIES | 80 mm



UNIT



4.92 x 9.84 x 3.14 in
125 x 250 x 80 mm
Units/bundle: 256
Units/layer: 32

Joint Width: 7 mm (9/32")
% Surface Opening: 8.4%
Infiltration Rate: mm/h 22,962

BUNDLE OVERVIEW

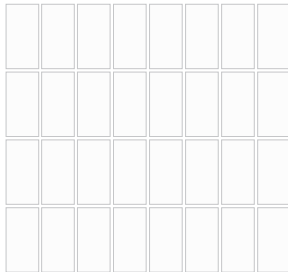

COLOURS



Colorado Grey

Grey

Grey Mix

BUNDLE SPECIFICATIONS

	IMPERIAL	METRIC
Coverage	86.08 ft ²	8 m ²
Weight	2900.9 lbs	1315.8 kg
Layers	8	
Coverage per layer	10.76 ft ²	1.0 m ²
Lineal coverage	104.96 / 209.92 ft	32 / 64 m
Lineal coverage per layer	13.12 / 26.24 ft	4 / 8 m



PATTERN

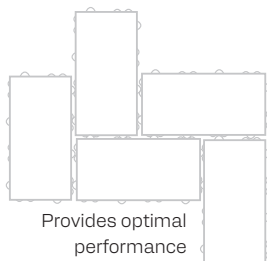

Provides optimal performance

NOTES

EcoFlow® delivers a clean, modern and sophisticated aesthetic. Manufactured using DesignLoc® technology, the two-step manufacturing process creates a refined top layer while reinforcing a strong, durable base. EcoFlow® is designed to have strategic spacer bars that create greater infiltration between units, enabling efficient water drainage meeting CMHA specifications.

For pedestrian and/or vehicular use.



PRECAST
& BUILDER
PRODUCTS



74	Forma™ Steps
75	Chimney Caps
76	Window Sills
76	Keystone
76	Deck Block (4 x 4)
77	Splash Pad
77	24" Step Riser
77	30" Step Riser
78	Accessories

FORMA™ STEPS

PRECAST BUILDER STEPS



UNITS

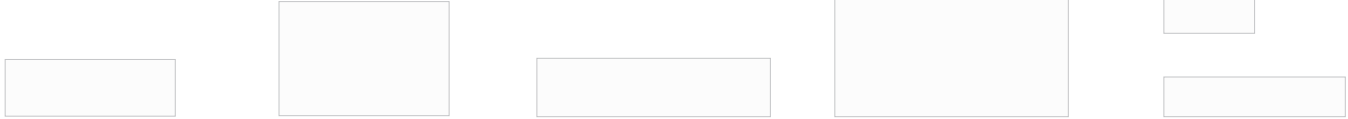

36" #1 Step

36w x 12d x 7h in
914w x 305d x 178h mm

36" #2 Step

36w x 24d x 7h in
914w x 610d x 178h mm

48" #1 Step

48w x 12d x 7h in
1219w x 305d x 178h mm

48" #2 Step

48w x 24d x 7h in
1219w x 610d x 178h mm

12" Filler

12w x 4.5d x 7h in
305w x 115d x 178h mm

24" Filler

24w x 5.25d x 7h in
610w x 135d x 178h mm

BUNDLE SPECIFICATIONS

36" #1	IMPERIAL	METRIC
Weight	1598 lbs	725 kg
Units	15	-

48" #1	IMPERIAL	METRIC
Weight	1712 lbs	776 kg
Units	12	-

36" #2	IMPERIAL	METRIC
Weight	1555 lbs	705 kg
Units	10	-

48" #2	IMPERIAL	METRIC
Weight	1874 lbs	850 kg
Units	10	-

12" Filler	IMPERIAL	METRIC
Weight	2280 lbs	1034 kg
Units	24	-

24" Filler	IMPERIAL	METRIC
Weight	2220 lbs	1006.97 kg
Units	12	-

STEP & FILLER CROSS SECTION

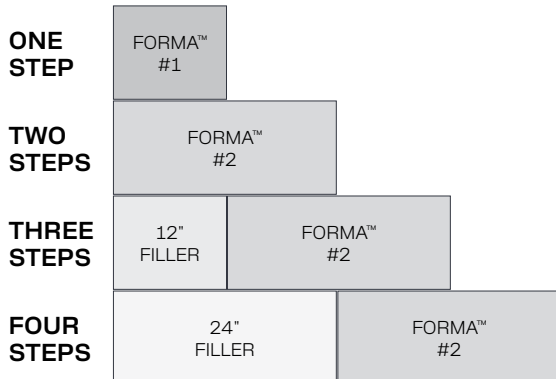

COLOUR



Off-White

NOTES

Forma Steps sold in full bundles only.

Fillers sold in pairs.



CHIMNEY CAPS

PRECAST BUILDER PRODUCT



UNITS



9" x 9" Cap

8.86w x 8.86d x 2.95h in
225w x 225d x 75h mm



9" x 13" Cap

8.86w x 13d x 2.95h in
225w x 330d x 75h mm



9" x 13" U-Cap

8.86w x 13d x 2.95h in
225w x 330d x 75h mm



Stringer

15.5w x 5.5d x 2.95h in
394w x 140d x 75h mm

BUNDLE SPECIFICATIONS

9" x 9" Cap

	IMPERIAL	METRIC
Weight	1334 lbs	605.09 kg
Units	20	-

9" x 13" Cap

	IMPERIAL	METRIC
Weight	1494 lbs	677.67 kg
Units	20	-

9" x 13" U-Cap

	IMPERIAL	METRIC
Weight	1128 lbs	511.65 kg
Units	20	-

Stringer

	IMPERIAL	METRIC
Weight	1808 lbs	820 kg
Units	96	-

COLOUR



Off-White

UNITS



WINDOW SILLS

36w x 5.9h x 2.95d in
914w x 150h x 75d mm

BUNDLE SPECIFICATIONS



	IMPERIAL	METRIC
Weight	2895 lbs	1313.24 kg
Units	56	-
Lineal coverage	168 ft	51.2 m
Lineal coverage per unit	3 ft	0.9 m

COLOURS



Charcoal

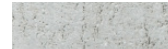

Grey

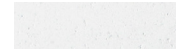

White



KEYSTONE

8.75/5.75w x 12.5h x 3d in
222/146w x 310h x 75d mm

	IMPERIAL	METRIC
Weight	1085 lbs	492.24 kg
Units	40	-

COLOURS

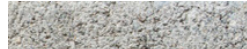

Grey

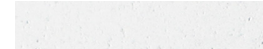

Off-White



**HEAVY DUTY
DECK BLOCK (4 x 4)**

11.81w x 7.48h x 11.81d in
300w x 190h x 300d mm

	IMPERIAL	METRIC
Weight	2520 lbs	1143.05 kg
Units	36	-

COLOURS

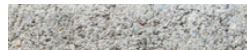

Grey

UNITS

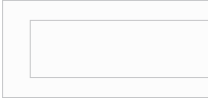

SPLASH PAD

23.62w x 10.83d x 3.15h in
600w x 275d x 80h mm

BUNDLE SPECIFICATIONS



	IMPERIAL	METRIC
Weight	1774 lbs	804.56 kg
Units	32	-

COLOURS

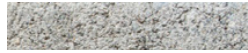

Grey



24" STEP RISER

23.62w x 5.9h x 3.74d in
600w x 150h x 95d mm

	IMPERIAL	METRIC
Weight	3168 lbs	1437 kg
Units	72	-

COLOURS

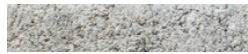

Grey

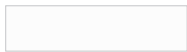

30" STEP RISER

29.52w x 5.9h x 3.74d in
750w x 150h x 95d mm

	IMPERIAL	METRIC
Weight	2310 lbs	1050 kg
Units	42	-

COLOURS

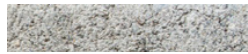

Grey

ACCESSORY ITEMS

JOINT SAND

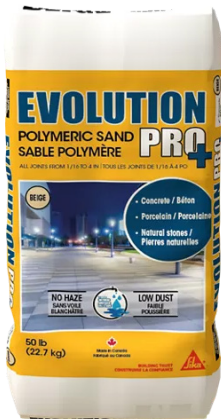

POLYMERIC SAND

Bag 50lbs (22.7kg) 63 bags / bundle

// Signature paver and slab coverage approximately 80-100 sqft/bag

// Classic paver coverage approximately 60-80 sqft/bag

COLOURS: Beige, Black and Grey

SEALERS & CLEANERS



SEAL KING SEALERS & CLEANERS

// Water and acrylic based (19L & 4L Pails)

// Semi Gloss and High Gloss

// Cleaning Products



KIMBOL SEALERS & CLEANERS

// Water and acrylic based (20L & 4L Pails)

// Regular and Super Shine

// Cleaning Products

ADHESIVES

BUTYL TAPE

1/4" Bead Roll 20 Lineal Feet 40 rolls/case

LANDSCAPE CONCRETE PAVERS & WALL ADHESIVE

Small Tube 10 Ounces 12 tubes/case

Large Tube 28 Ounces 12 tubes/case

AGGREGATES

BRICK SAND

Bag 50lbs (22.7kg)

*Regular paver coverage approximately 100 sqft/bag

CONCRETE SAND

Yard

*1 yard covers approximately 300 sqft at 1" thickness

LIMESTONE SCREENING

Bag / Yard 50lbs (22.7kg)

*1 yard covers approximately 150 sqft at 2" thickness

1/2" GRAVEL (Clear) Yard

*1 yard covers approximately 150 sqft at 2" thickness

3/4" GRAVEL (Clear)

Bag 50lbs (22.7kg)

1/4" CHIP (HPB)

Bag / Yard 50lbs (22.7kg).

*1 yard covers approximately 150 sqft at 2" thickness

FABRICS

SYNTHETIC GRID

Miragrid3XT 6' x 150' (1.83m x 45.72m)

12' x 150' (3.65m x 45.72m) [Special Order]

CONSTRUCTION FABRIC

Nonwoven Geotextile 5' x 360' (1.52m x 109.7m)

Nonwoven Geotextile 4' x 50' (1.2m x 15.2m)

Nonwoven Geotextile 3' x 50' (0.9m x 15.2m)

PRECAST CONCRETE

PARKING LOT BUMPER CURBS

96x12x8" (2438x305x203mm)

520 lbs / 236.4 kg (unit)

96x10x6" (2438x254x152mm)

360 lbs / 163.6 kg (unit)

TOOLS

Pave Tool Quick-E Line

Caulking guns

Gloves

Hand tampers

Mallets

Levels

Plate tampers

Shovels

String lines

Wheelbarrows

+ MORE



EDGE RESTRAINTS

BRICKSTOP PAVER EDGE RESTRAINT

PLASTIC 8' Units 160 lineal feet/box 20 units/box

METAL 8'4" Units 400 lineal feet/box 48 units/box

SPIKES 10" Steel approx. 50lbs 235 pcs/ box



	Beige Mix	Carrara	Charcoal	Colorado Grey	Ebony	Fond Du Lac	Glacier Creek	Granite	Granite Grey	Grey	Grey Mix	Manitou Blend	Nightfall	Off-White	Sandstone Taupe	Summer Mist	Ultra Black	Weatherwood	Winterborn
Walls																			
Arlington				x							x		x			x			x
Stacker Antico & Classic Smooth	x										x						x		
Barnbeam																		x	
Garden Lock	x								x	x									x
Grand Ledge						x						x							
Hazlelton	x										x						x		
Ikon										x							x		
Parkwall	x									x	x								x
RidgeWall										x									
RidgeWall Smooth										x									
Rockton						x						x							
Soho		x					x				x				x		x		
Copings																			
28 x 28 Smooth Column Cap					x				x										
Barollo 8"				x									x			x			
Barollo 10"										x							x		
Garden Lock	x									x	x						x		x
Montana Cap					x			x											
Parkwall	x									x	x						x		x
Parkwall Column Cap										x							x		
Sopra Coping										x							x		
Steps																			
Camden Step					x				x										
Forma Step														x					
Ikon Step										x							x		
Ridge Step										x	x								
Curbs																			
Antico	x										x								
Arlington				x							x		x			x			x
Driveway			x							x									
Garden			x							x									

Colour swatches and photographs are not exact representations of colour, but are given to provide close reference.

Measurements and product dimensions are nominal.

Registered trademarks, logos and product names are the property of Best Way Stone Limited®.

022026R1



Parkwall®, Parkwall®, Garden Lock™ US Patents 6398458 & 6178715; Canadian Patent 2193942.

RidgeWall® US Patent Pending 20140270989; Canadian Patent Pending 2809704.

INSTALLATION GUIDES - SLABS & PAVERS

SLAB INSTALLATION TYPICAL CROSS SECTION

- 1 Best Way Stone® precast concrete slab (1.77'+) (45mm+)
- 2 Sand joint fill
- 3 Bedding Sand 1" (25mm)
- 4 Geotextile 12" (300mm) wide
- 5 Plastic edge
- 6 Extra width equal to foundation thickness
- 7 Lawn
- 8 Nail
- 9 Compacted aggregate base 0 3/4" (0-20mm)
- 10 Geotextile
- 11 Subgrade

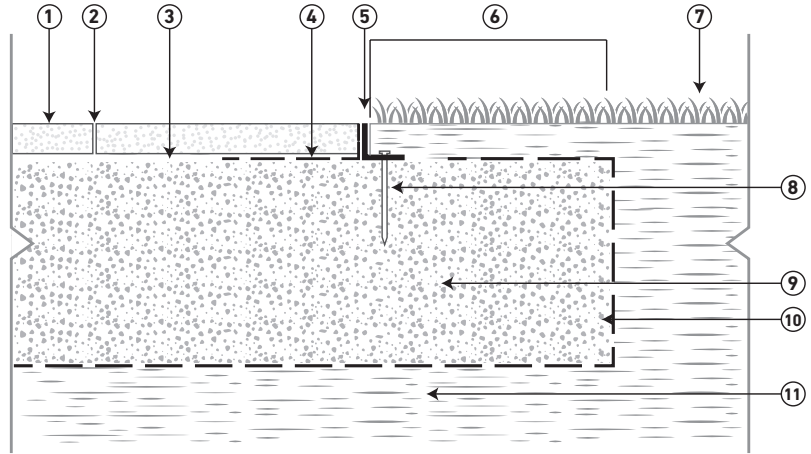

SLABS ON PEDESTAL SET

- 1 Roof deck
- 2 Waterproof membrane
- 3 Protection board
- 4 Rigid insulation
- 5 Adjustable pedestal
- 6 Best Way Stone® precast concrete slab (1.77'+) (45mm+) thickness conforming to ASTM C 1782 and CSA A231.1
- 7 Best Way Stone® precast concrete slab (1.77'+) (45mm+) thickness conforming to ASTM C 1782 and CSA A231.1
- 8 Roof drain

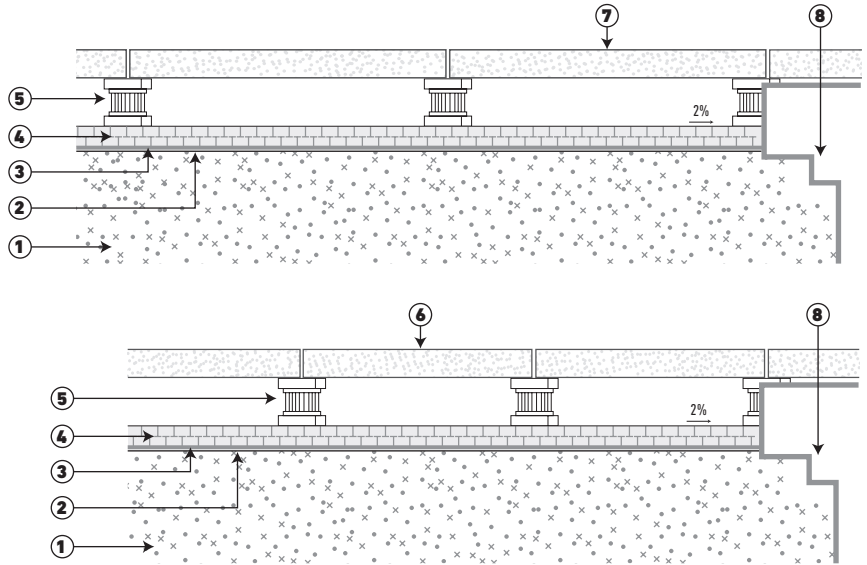

When installing slabs on a pedestal set, ensure to consider load requirements. Refer to a project engineer for specific considerations.

TYPICAL PAVER CROSS SECTION WITH PLASTIC EDGE

- 1 Best Way Stone® precast concrete paver 2 3/8" (60mm) thick min.
- 2 Sand joint fill
- 3 Bedding Sand 1" (25mm)
- 4 Extra width equal to foundation thickness
- 5 Lawn
- 6 Plastic edge
- 7 Nail
- 8 Geotextile
- 9 Compacted aggregate base 0 - 3/4" (0-20mm)
- 10 Subgrade

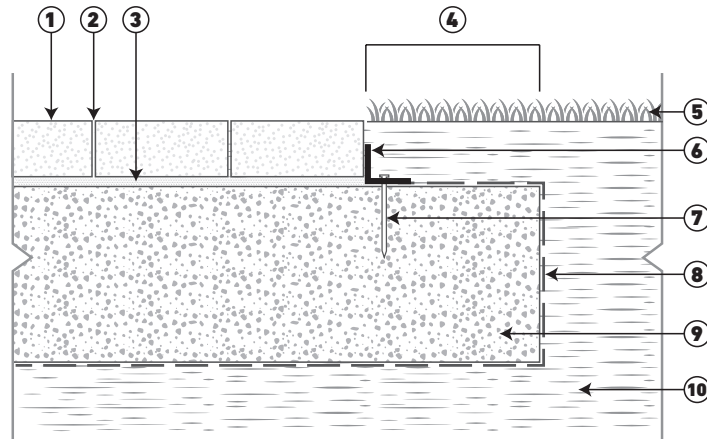

INSTALLATION GUIDES - PERMEABLE PAVER SYSTEM

SEGMENTAL PERMEABLE PAVEMENT - FULL EXFILTRATION

- 1 EcoFlow® Permeable Paver by Best Way Stone®
- 2 Joint filling material ASTM No 8 (CSA 2.5-10mm) aggregate
- 3 Bedding course 1 1/5" to 2" (40 to 50 mm) ASTM No 8 (CSA 2.5-10mm) aggregate
- 4 Base course 4" (100mm) ASTM No 57 (CSA 5-28mm) aggregate foundation thickness
- 5 Subbase course ASTM No 2 (CSA 40-80mm) aggregate
- 6 Geotextile
- 7 Subgrade
- 8 Concrete edge

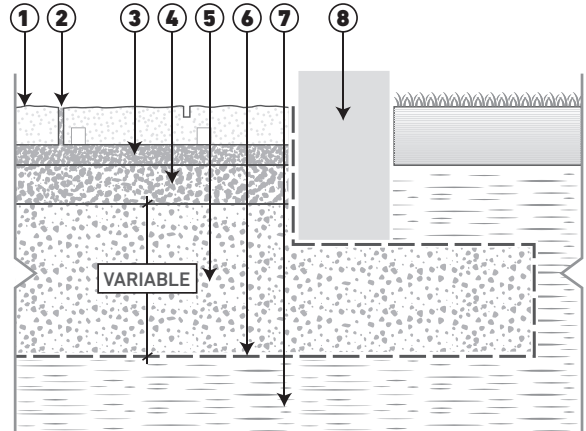

SEGMENTAL PERMEABLE PAVEMENT - PARTIAL EXFILTRATION

- 1 EcoFlow® Permeable Paver by Best Way Stone®
- 2 Joint filling material ASTM No 8 (CSA 2.5-10mm) aggregate
- 3 Bedding course 1 1/5" to 2" (40 to 50 mm) ASTM No 8 (CSA 2.5-10mm) aggregate
- 4 Base course 4" (100mm) ASTM No 57 (CSA 5-28mm) aggregate foundation thickness
- 5 Subbase course ASTM No 2 (CSA 40-80mm) aggregate
- 6 Geotextile
- 7 Subgrade
- 8 Concrete edge
- 9 Perforated drain connected to drainage system

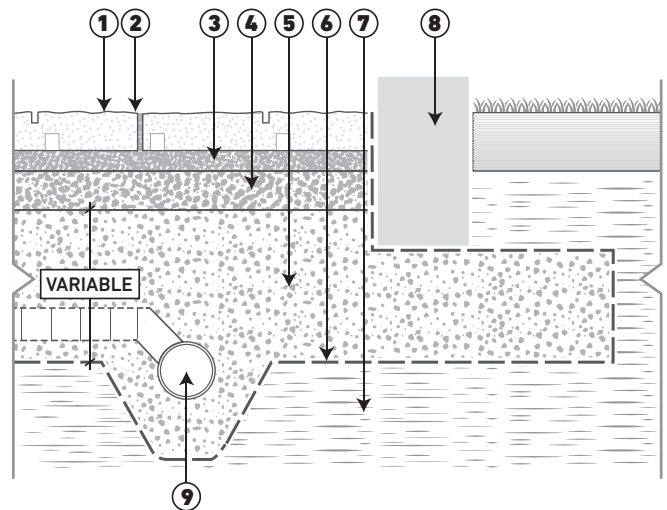

SEGMENTAL PERMEABLE PAVEMENT - NO EXFILTRATION

- 1 EcoFlow® Permeable Paver by Best Way Stone®
- 2 Joint filling material ASTM No 8 (CSA 2.5-10mm) aggregate
- 3 Bedding course 1 1/5" to 2" (40 to 50 mm) ASTM No 8 (CSA 2.5-10mm) aggregate
- 4 Base course 4" (100mm) ASTM No 57 (CSA 5-28mm) aggregate foundation thickness
- 5 Subbase course ASTM No 2 (CSA 40-80mm) aggregate
- 6 Geotextile
- 7 Subgrade
- 8 Concrete edge
- 9 Perforated drain connected to drainage system
- 10 Impermeable membrane

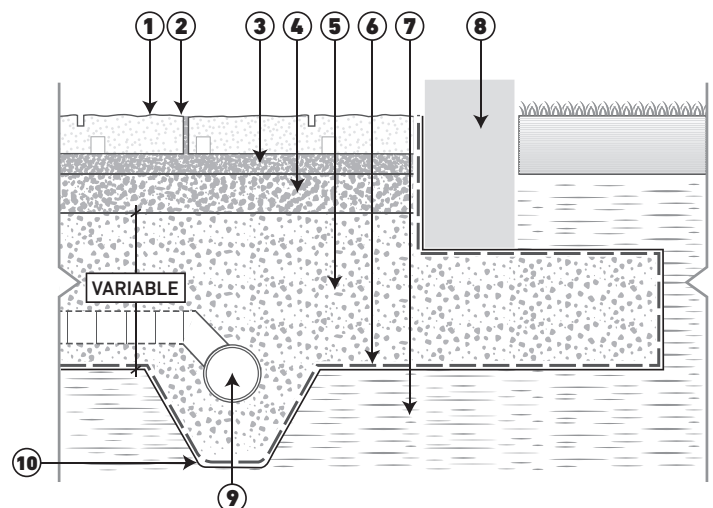

INSTALLATION GUIDES - RETAINING WALLS

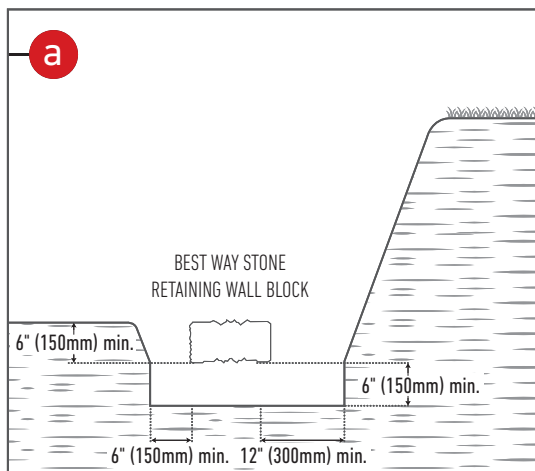

a. EXCAVATE THE AREA

1. Check for existing utilities or structures in the area of construction.
2. Dig a trench. Calculate the width of the area by adding 6" of space before the face of the wall, and 12" behind the wall block.
3. Calculate the depth of the trench by the burial depth of the wall. Consider that good practice is to have at least 10% of the total wall height buried below final grade.

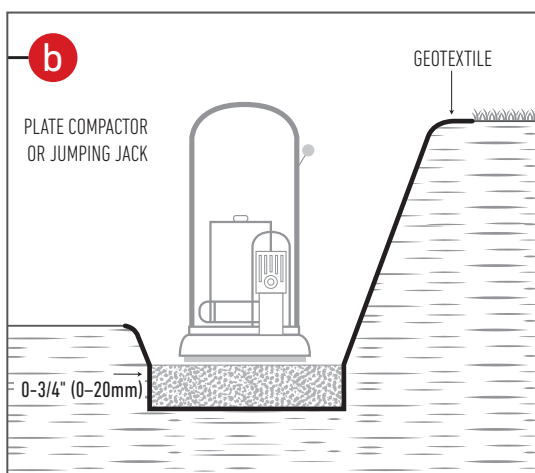

b. PREPARE THE FOUNDATION

1. Cover the back and the base of the trench with geotextile. Extend the geotextile along the back of the excavated area to eventually above the drainage fill once in place at the top of the wall.
2. Spread 0-3/4" (0-20mm) stone in the trench, and compact using a vibrating plate compactor or a jumping jack. Make sure your area remains level after compaction. The compacted area must be at least 6" (150mm) thick. Add more stone if needed and compact again.

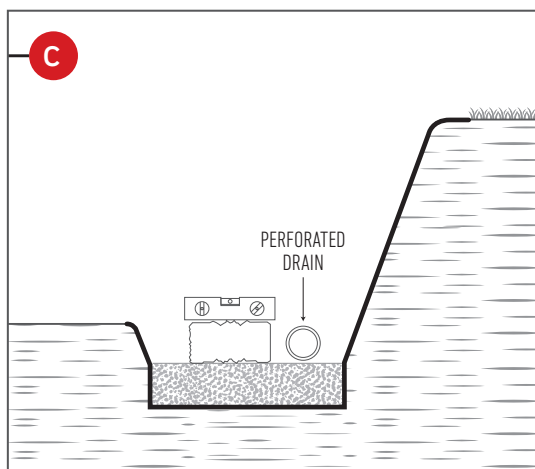

c. CONSTRUCT THE FIRST COURSE

1. Begin placing your first course of the Best Way Stone blocks along your leveled pad. Ensure the alignment and level are consistent.
2. The desired exposed face of the wall must be placed side by side with each block touching the next. There should be no space between block faces of the exposed side of the wall.
3. Add a perforated drain pipe at the back of the wall on top of the leveled stone base. Ensure to connect this pipe to the existing drainage system keeping water from accumulating behind the wall.

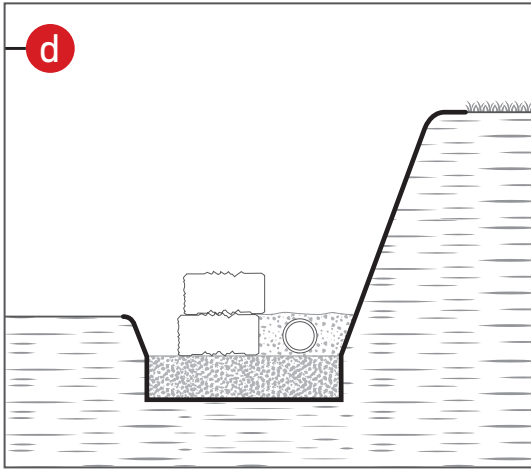

d. ADD THE BACKFILL

1. Add 0-3/4" (0-20mm) clean stone backfill to the rear of the wall, burying the perforated drain pipe. Ensure the geotextile remains along the backside as you backfill all the way up the wall, and does not fall into the backfill material.
2. Level the clean stone before constructing the next course. Ensure to fill all voids in the back of the wall with backfill.

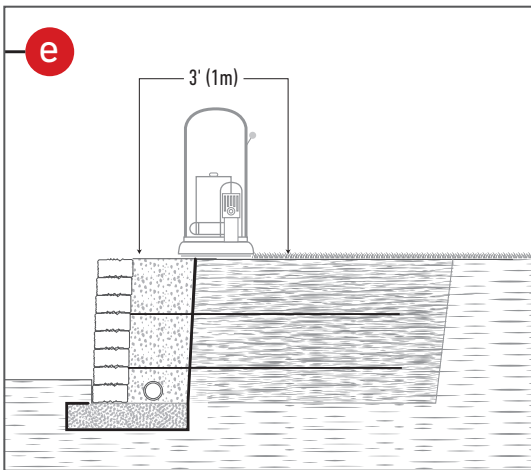

e. THE REMAINING COURSES

1. When constructing the remaining courses ensure to clean off the top of blocks of the previous row. Make sure the blocks are installed with the appropriate side facing up following the locking system.
2. Backfill behind each constructed course with the same clean stone.
3. In order to maximize the strength of the wall, ensure that the joints of the row being constructed do not align with the row directly below or above. The joints of a course should match alternating courses.

CARE & CONSIDERATIONS

SETTING A BASE

The quality of work put into establishing a solid foundation is vital to the overall performance of your landscape design.

When properly constructed, a solid base foundation helps prevent paver settling, shifting, and water accumulation. Use of edge restraints and jointing sand is recommended as best practice by CMHA (Concrete Masonry & Hardscapes Association).

When choosing and installing jointing sand, please ensure to follow the directions given by the manufacturer. To find out more about base preparation and installation practices, visit masonryandhardscapes.org.

COLOUR DISTRIBUTION

When installing stone, we recommend you select a mix of materials from several different bundles to ensure a balanced distribution of surface colour textures and colour mixtures.

Always verify colours and products chosen for your concrete landscape project with your contractor or landscape designer prior to installation. Physical or printed colour samples are only representations of the chosen product. If you notice a discrepancy, notify us immediately before continuing with your project. Full installation is understood as your acceptance of the product's condition.

CONCRETE CARE

Maintaining the surface of your concrete pavers is essential to their aesthetic. Sealing your concrete pavers can enhance the colour, but it's optional as our pavers are just as durable with or without the addition of sealants. If you plan on sealing your concrete products, always follow the manufacturer's instructions for proper application.

Unfortunately, even materials as durable as concrete can scratch, chip, or stain if handled incorrectly. When compacting our pavers, ensure that a rubber membrane is added to protect textured surfaces from potential damage. Use a rubber blade when removing snow from the surface of our pavers to prevent surface scratching and damage. Best Way Stone is not responsible for the damage left by the misuse of compaction or snow removal equipment.

EFFLORESCENCE

Efflorescence is that white, powdery substance that appears on the surface of concrete and it's a naturally occurring process. Efflorescence does not affect the structural integrity or strength of the product and will usually wear off over time – although special cleaners can be used to speed up its removal. For more information visit masonryandhardscapes.org.

CHOOSING A CONTRACTOR

Although not required, hiring a qualified contractor makes installing stone a much more efficient and less stressful experience. When hiring a qualified professional, we recommend they follow industry standard guidelines.

When hiring a contractor, we recommend collecting project references and samples of previous work. Make sure they offer a comprehensive warranty, and have all the required insurance and licenses. Any contractor will understand the industry standards for installing stone - you can download a copy of these guidelines by visiting masonryandhardscapes.org.



OUR GUARANTEE - CARVED IN STONE

Best Way Stone Limited provides a transferable lifetime guarantee on the structural integrity of its Interlocking Paving Stone Products for residential use. For complete information visit bestwaystone.com/warranty.



Woodbridge & Uxbridge Outdoor Design Centres

Speak to our customer service experts to help bring your design to life. Feel free to bring samples home along with some peace of mind.



**Uxbridge Outdoor
Design Centre**
65 Anderson Boulevard
Uxbridge, ON
L9P 0C7

**Woodbridge Outdoor
Design Centre**
8821 Weston Road
Woodbridge, ON
L4L 0K9



SAFETY PRECAUTIONS

CAUTION! Product strapping under extreme tensions

Cut straps are sharp and may result in severe physical injury if proper precautions are not taken. Removal and handling of straps must be done with caution while wearing necessary protective equipment (Gloves, Goggles, Safety Boots, and Protective Clothing).

Concrete Materials must be cut in well-ventilated areas only. Use of a “Wet-Cut” Saw or other similar method is recommended to reduce hazardous dust production. Approved respirators, safety goggles, hearing protection, and gloves should be worn at all times.

Bundled material must always be transported and stored using appropriate equipment, meeting the regulations of local legislation (Transportation tie-down, vehicle weight limitations, and public storage location). Stacking more than two bundles on top of each other is not recommended.

Best Way Stone Limited® assumes no liability or responsibility for loss or damage resulting from the improper use or handling of our products, or from failure to follow instructions, warnings, and/or advisories on the product label and on the MSDS Precast Concrete Sheet (available upon request).

BEFORE OPENING ANY PRODUCTS:

Please check for correct colour and product (shape/size/design). Opening of this package (removal of strapping and/or shrink wrapping) assumes full acceptance of product by the purchaser. Material may not be returned or exchanged once the original packaging has been removed.

All concrete products may have significant colour variance between production lots. It is recommended that installation occur from multiple bundles simultaneously to ensure proper colour variance blending for both colour mixes and solid colours. In the case of a single-bundle installation, material should be installed from opposite ends of the bundle simultaneously.

Defective material delivered to the purchaser over the accepted norm will be replaced. (Please Note: Chipped and Cracked products are often used in areas where cutting is required. As such, please remove chipped or cracked products for this purpose). The purchaser must inform the manufacturer in writing within five days of delivery. Any materials in question must be available for inspection by Best Way Stone® before any credit or adjustment can be made.

PLEASE NOTE: If materials are completely or partially installed, they will be deemed acceptable and there will be no exceptions made for defective or unsatisfactory material.

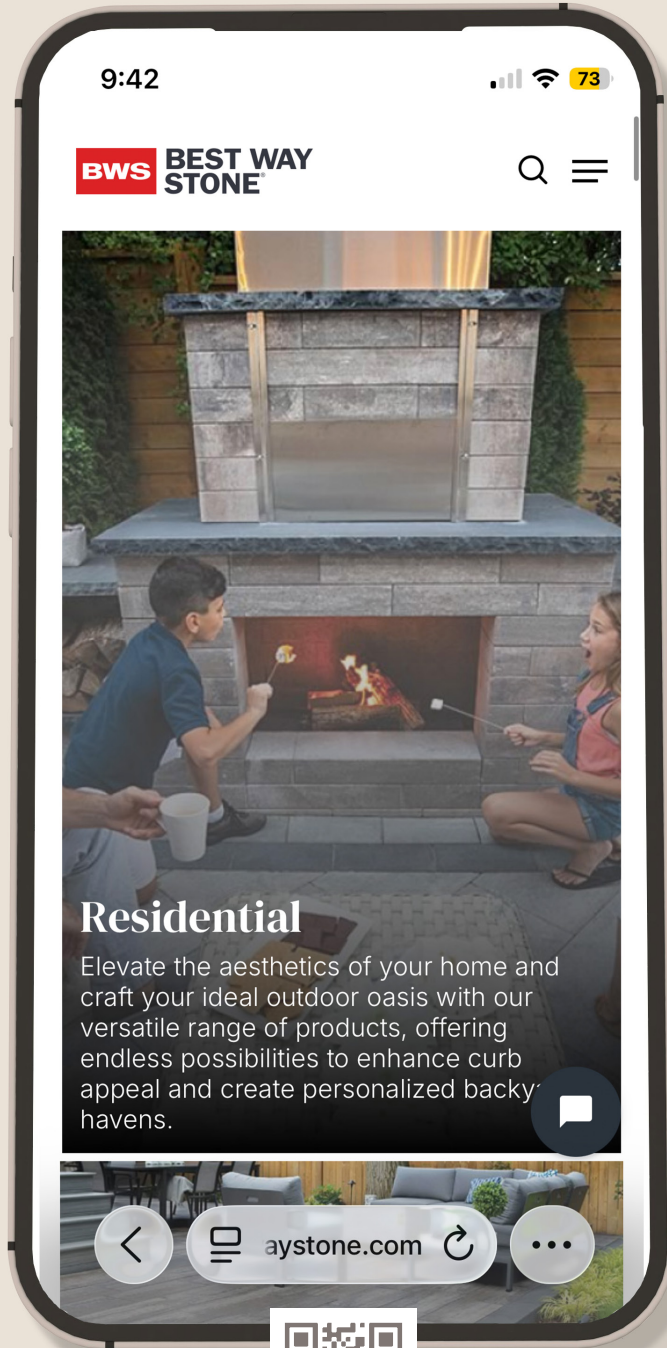

Our website is your ultimate destination for all things Best Way Stone! Scan the QR code to dive into our latest products, design inspiration and everything you need to bring your projects to life.



OUR LOCATIONS

WOODBRIIDGE

8821 Weston Rd
Woodbridge, ON
L4L 0K9

1-800-BESTWAY
(2378929)

T (905) 851-5122
T (416) 747-0988
F (905) 851-7603

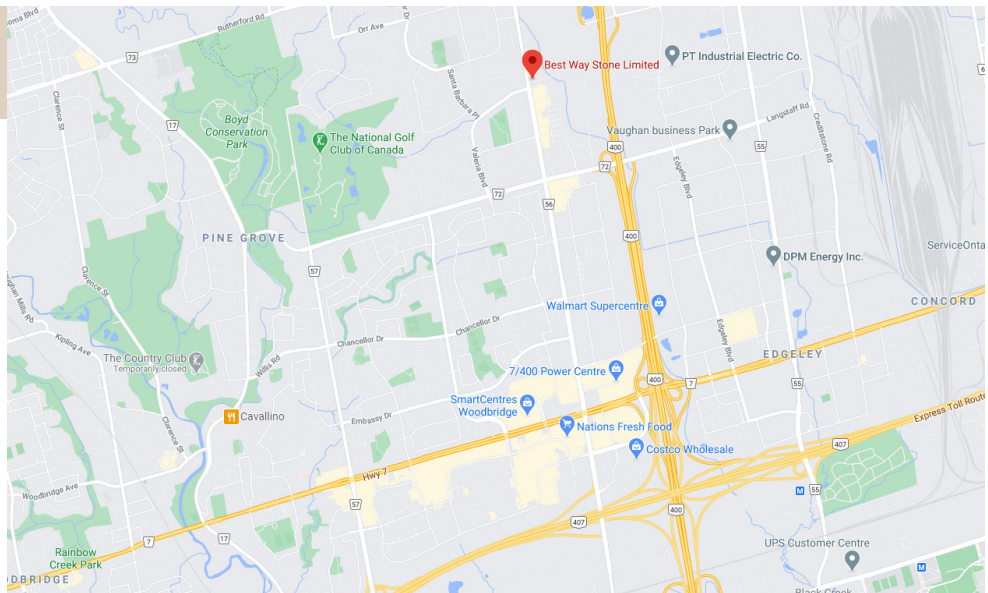

UXBRIDGE

65 Anderson Blvd
Uxbridge, ON
L9P 0C7

T (905) 640-5845
F (905) 640-9773

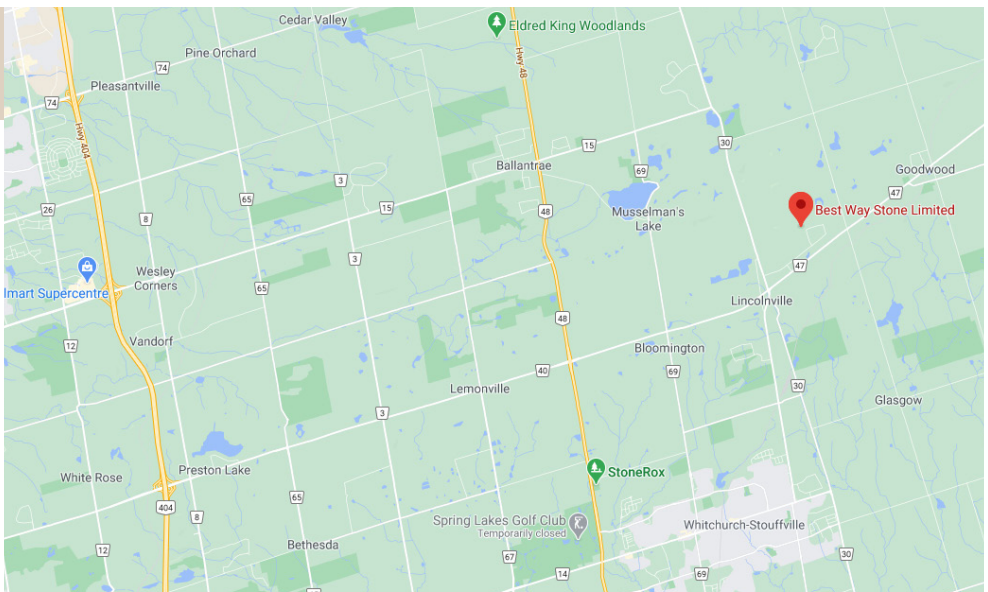



2026 PRODUCT GUIDE

1-800-BESTWAY (237-8929)
www.bestwaystone.com

Woodbridge (Head Office)

8821 Weston Road
Woodbridge, ON L4L 0K9
T 905-851-5122
F 905-851-7603

Uxbridge

65 Anderson Boulevard
Uxbridge, ON L9P 0C7
T 905-640-5845
F 905-640-9773



@bestwaystone



@bestwaystone



facebook/bestwaystone



@bestwaystone

Provided by: